

Manchester Township Bureau of Inspections
1 Colonial Drive
Manchester, New Jersey 08759

732-657-8121

Pool Installation Guide

1. This handout is based on the **2015 International Residential Code NJ**, and the **2014 National Electric Code** for single-family dwellings. This is only a guide and cannot cover every situation that you may encounter.
2. Permits are required for both in-ground and above ground pools more than 24" deep.
3. Plans are required for in-ground or semi-in-ground-pools. Plans must be submitted in order to verify compliance with Standard ISPSC-15. Plans shall bear the seal and signature of a N.J. licensed design professional.
4. A sealed survey of your property will be required, indicating the location of the pool and fence.
5. Required Permits:
 - **Building** for the pool, fence and deck (if planned).
 - **Electric** for pump motor, lights (if any) and pool bond.
 - **Plumbing** for gas piping to heater (if any) and drains which need a hydrostatic-pressure test.
6. Required Inspections:
 - **Building**- In ground: Concrete lock around pool walls, collar and Final.
Above ground: Footing (for deck footings if planned) and Final.
 - **Electric**- Rough (before any trenched wires are backfilled or any bond wires are covered) and Final.
 - **Plumbing**- Rough (for gas piping with pressure test to be inspected by plumbing inspector) and Final.

Pool Enclosure Requirements

Private swimming pools must be surrounded by a barrier, such as a fence or wall. The barrier must meet the following requirements.

1. The top of the barrier shall be at least **48 inches** above finished ground level measured on the side of the barrier, which faces away from the swimming pool. The maximum vertical clearance between finished ground level and the bottom of the barrier shall be 2 inches measured on the side of the barrier, which faces away from the swimming pool. Where the top of the pool structure is above finished ground level, such as an above-ground pool, the barrier shall be at finished ground level, such as the pool structure, or shall be mounted on top of the pool structure. Where the barrier is mounted on the pool structure, the opening between the top surface of the pool frame and the bottom of the barrier shall not allow passage of a 4-inch diameter sphere.
2. Openings in the barrier shall not allow passage of a **4-inch** diameter sphere.

3. Solid barriers shall not contain indentations or protrusions except for normal construction tolerances and tooled masonry joints.
4. Where the barrier is composed of horizontal and vertical members and the distance between the tops of the horizontal members is less than 45 inches, the horizontal members shall be located on the swimming pool side of the fence. Spacing between vertical members shall not exceed 1-3/4 inches in width. Decorative cutouts shall not exceed 1-3/4 inches in width. (figure 1)

Fences with horizontal rails less than 45" apart

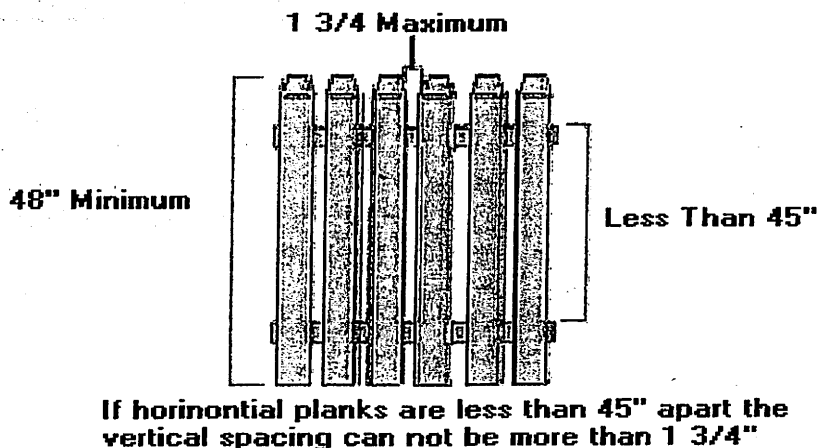
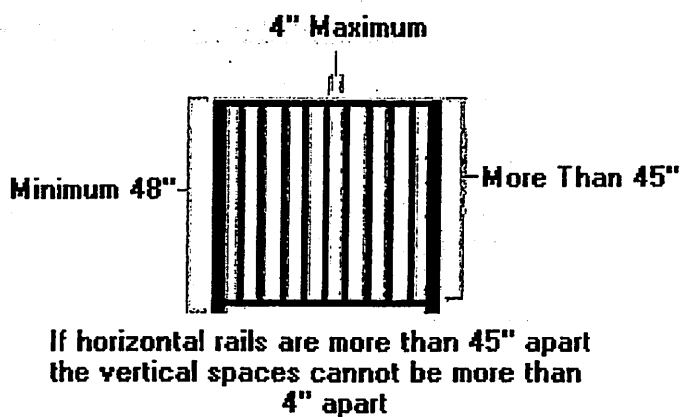

Figure 1

5. Where the barrier is composed of horizontal and vertical members and the distance between the tops of the horizontal members is 45 inches or more, spacing between vertical members shall not exceed 4 inches. Decorative cutouts shall not exceed 1-3/4 inches in width. (Figure 2)

Fences with horizontal rails more than 45"aparts



Spacing between vertical members shall be 3 7/8" so as to not allow a 4" sphere to pass through it.

Figure 2

6. Maximum mesh size for chain link fences shall be a 2 ¼-inch square unless the fence is provided with slats fastened at the top or the bottom which reduce the openings to not more than 1 ¾-inches. See sample attachment from ISPSC-15 Code.

than $1\frac{3}{4}$ inches (44 mm) to prevent a child from gaining a foothold to scale the fence [see Commentary Figure 305.2.5(2)].

Commentary Figure 305.2.6(2) shows a barrier. The fence is known to be 4 feet (1219 mm) high. It is obvious that the distance between the horizontal rails is less than 45 inches (1143 mm) and the vertical pickets spaced wider than 1.75 inches (44 mm). Thus, this fence is a violation because the horizontal members are not at least 45 inches (1143 mm) apart.

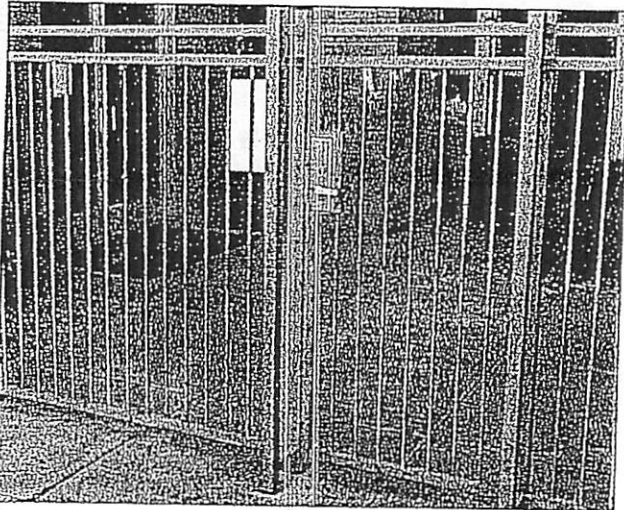

FIGURE 305.2.6(2)
VIOLATION—BARRIER (FENCE) HORIZONTAL MEMBERS TOO CLOSE

305.2.7 Chain link dimensions. The maximum opening formed by a chain link fence shall be not more than $1\frac{3}{4}$ inches (44 mm). Where the fence is provided with slats fastened at the top and bottom which reduce the openings, such openings shall be not more than $1\frac{3}{4}$ inches (44 mm).

❖ Chain link fencing has diamond-shaped or square openings. The most common sizes of chain link openings (measured between parallel sides of the opening) are 2 inches (51 mm) and $2\frac{1}{4}$ inches (57 mm). This section requires that the openings be not greater than $1\frac{3}{4}$ inches (44 mm) so that a child cannot wedge his or her foot in the opening in order to climb the fence (see Commentary Figure 305.2.7). Two-inch (51 mm) and $2\frac{1}{4}$ -inch (57 mm) chain link fence must have the openings reduced in size by the installation of slats (sometimes called privacy slats) vertically or diagonally. Where slats are used, they must be attached to the top and bottom of the fence so that they cannot be removed for gaining a hand- or foothold on the fence. The slats must be of a width that reduces the openings to less than $1\frac{3}{4}$ inches (44 mm).

Chain link fencing is also available in $1\frac{1}{4}$ -inch (32 mm) size (mesh). The resulting diagonal opening is $1\frac{3}{4}$ inches (44 mm). Therefore, slats would not be required for this size of chain link fence.

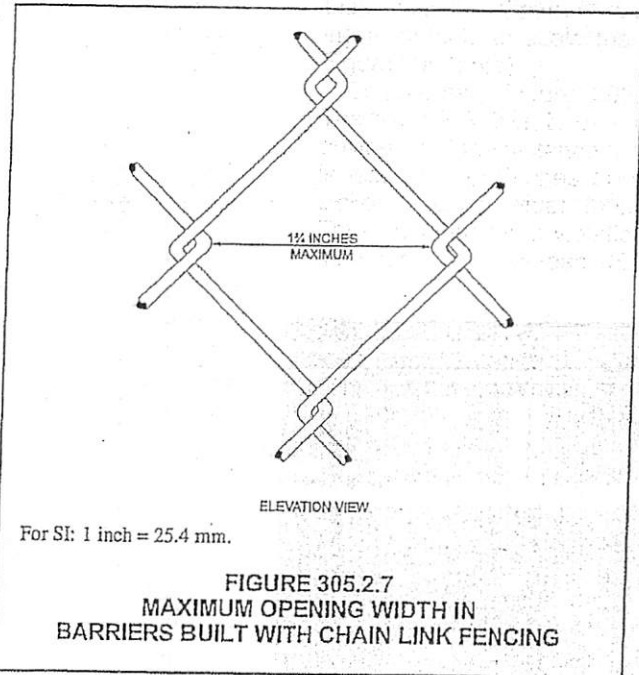

FIGURE 305.2.7
MAXIMUM OPENING WIDTH IN BARRIERS BUILT WITH CHAIN LINK FENCING

305.2.8 Diagonal members. Where the barrier is composed of diagonal members, the maximum opening formed by the diagonal members shall be not more than $1\frac{3}{4}$ inches (44 mm). The angle of diagonal members shall be not greater than 45 degrees (0.79 rad) from vertical.

❖ Some barrier designs use diagonal members (lattice-work) as part of the barrier. Where diagonal members are installed, the angle cannot be more than 45 degrees (0.79 rad) from vertical and the opening created by the diagonal members cannot be greater than $1\frac{3}{4}$ inches (44 mm) so a child cannot wedge a foot in the opening to climb the barrier (see Commentary Figure 305.2.8).

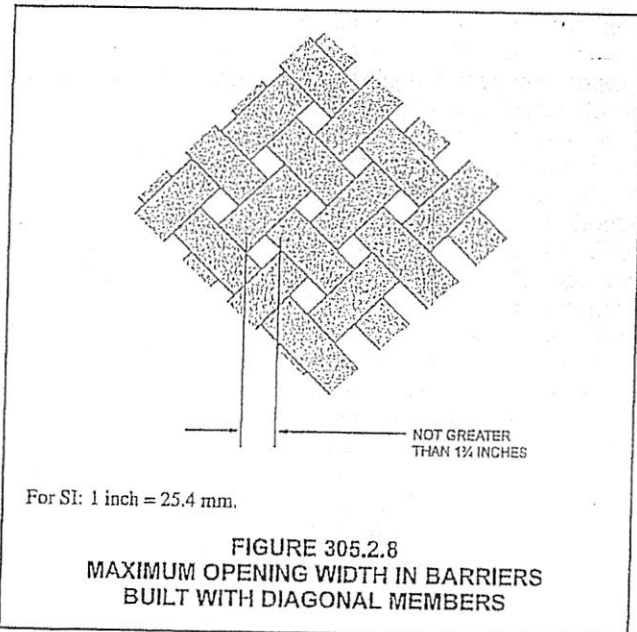
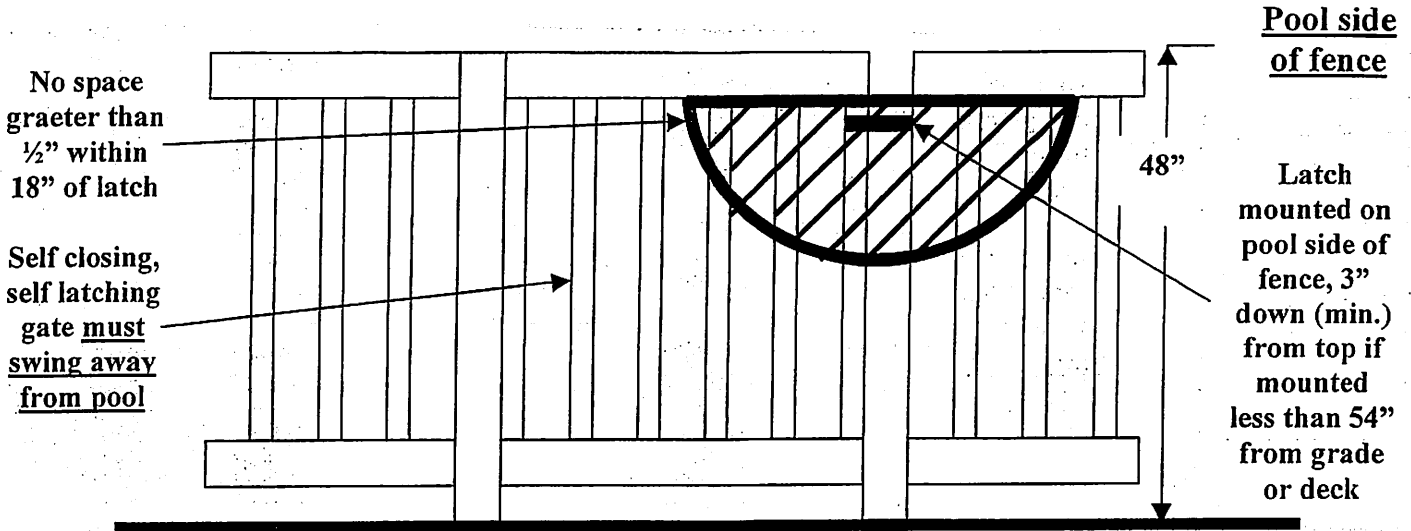

FIGURE 305.2.8
MAXIMUM OPENING WIDTH IN BARRIERS BUILT WITH DIAGONAL MEMBERS

Latch mounting position if mounted less than 54" high



If latch is mounted less than 54" from grade, it must be mounted on the pool side of the gate, a minimum of 3" down from the top of the gate and have no space greater than 1/2" within 18" of the latch.

Figure 4

Requirements for gates leading to pool

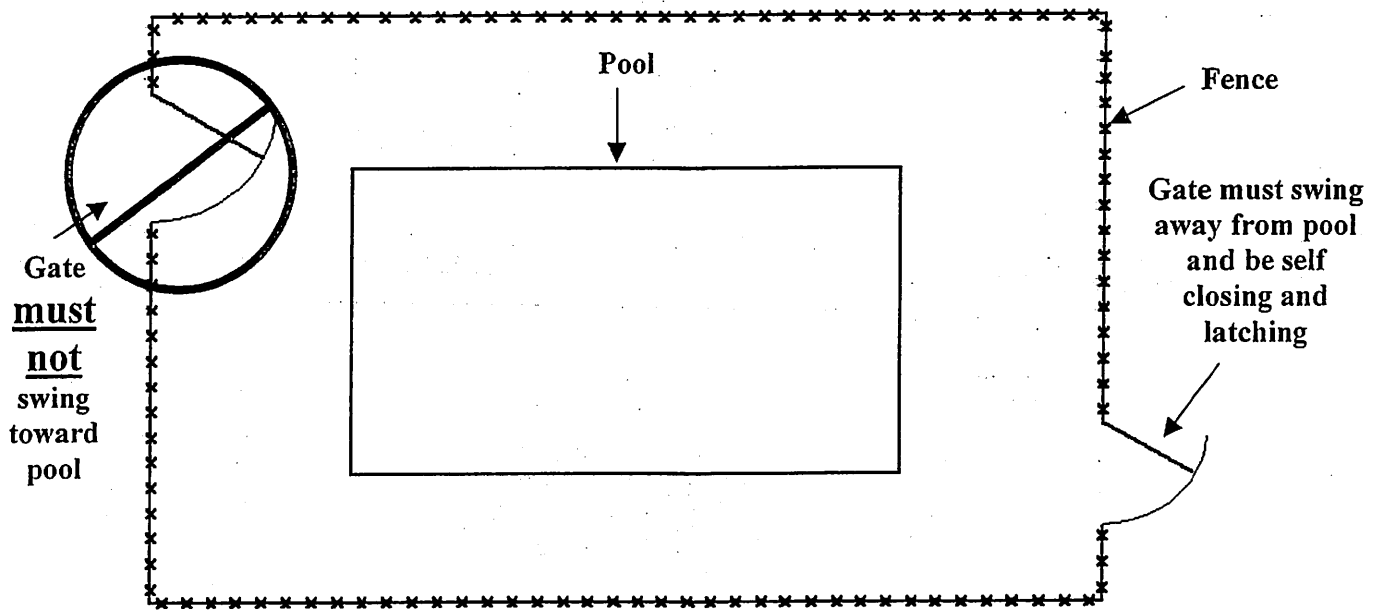

Figure 5

7. Where an above-ground pool structure is used as a barrier or where the barrier is mounted on top of the pool structure, and the means of access is a fixed or removable ladder or steps, the ladder or steps shall be surrounded by a barrier, which meets the

release. The inside (backside of the gate) release mechanism must be protected against tampering from the outside of the gate by providing a solid panel or mesh with openings of not greater than 1/2 inch (12.7 mm). The panel or small opening mesh must extend not less than 18 inches (457 mm) in all directions of the inside latch-release mechanism [see Commentary Figure 305.3.3(1)].

This section reflects the "traditional approach" for latch-release mechanisms on pedestrian access gates to pool and spa areas. Although suitable for most residential (as defined by this code) pool and spa access gates, this approach might not coordinate with designs for accessibility and controlled access needs in a public environment. For example, a latch-release on the inside (backside) of the gate or at a 54-inch height above the walking surface on either side of a gate is out of the reach range for persons seated in a wheelchair. Key card or key entry might also be necessary to control when the pool or spa can be used and who can use the pool or spa [see Commentary Figure 305.3.3(2)]. Therefore, the designer of the barrier system and pedestrian access gate for a public environment will need to assess each gate arrangement against all code requirements

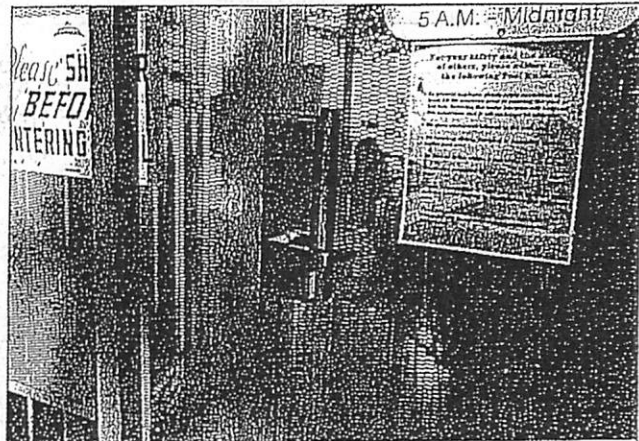
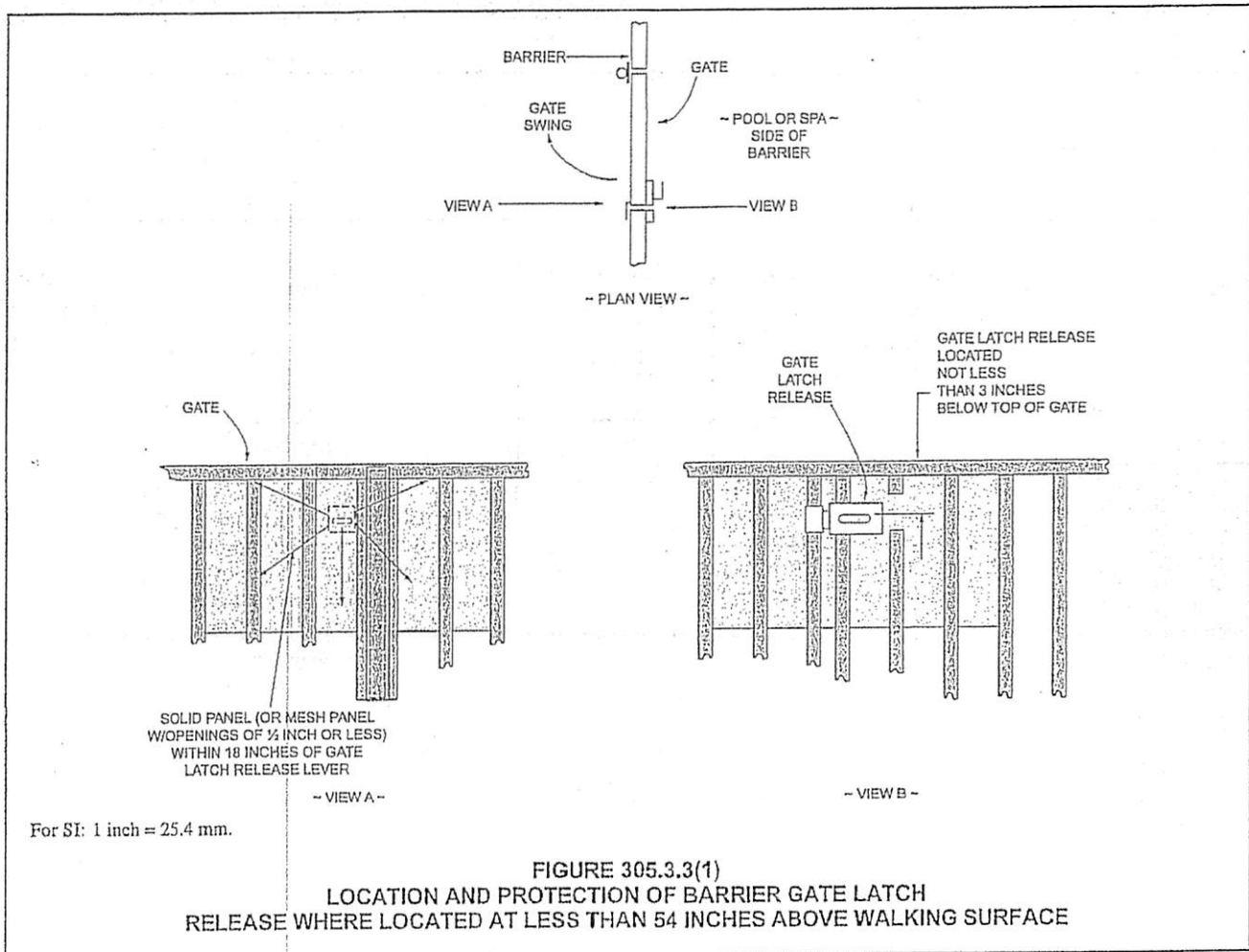

FIGURE 305.3.3(2)
KEY CARD ENTRY ON GATE TO POOL AND SPA AREA MIGHT REQUIRE ALTERNATIVE METHOD APPROVAL

and the needs of the client in order to propose an alternative method to the code official for compliance to this section (see Section 104.11).



requirements of items 1 through 6. A removable ladder shall not constitute an acceptable alternative to enclosure requirements. (Figure 7, 8 and 9)

Ladder Enclosure

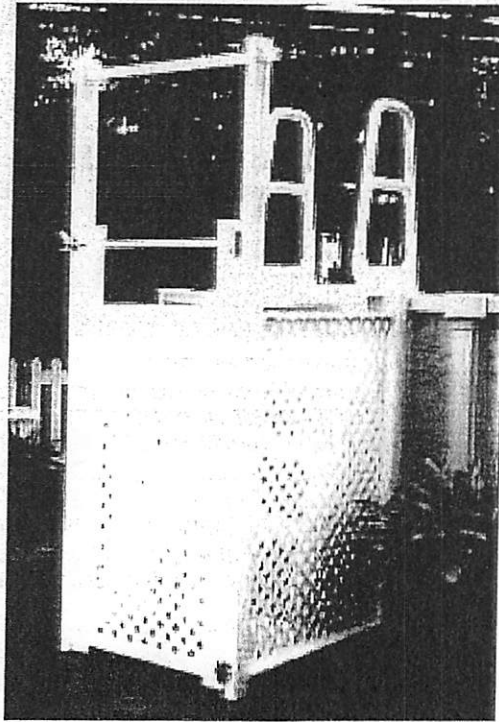

Figure 7

Maximum Space Between Top Mounted Barrier and Pool Wall

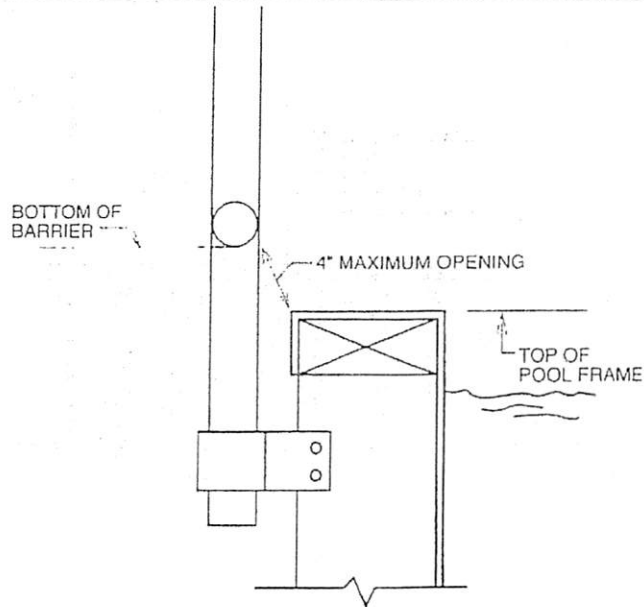

Figure 8

Pool with top mounted barrier and stair gate

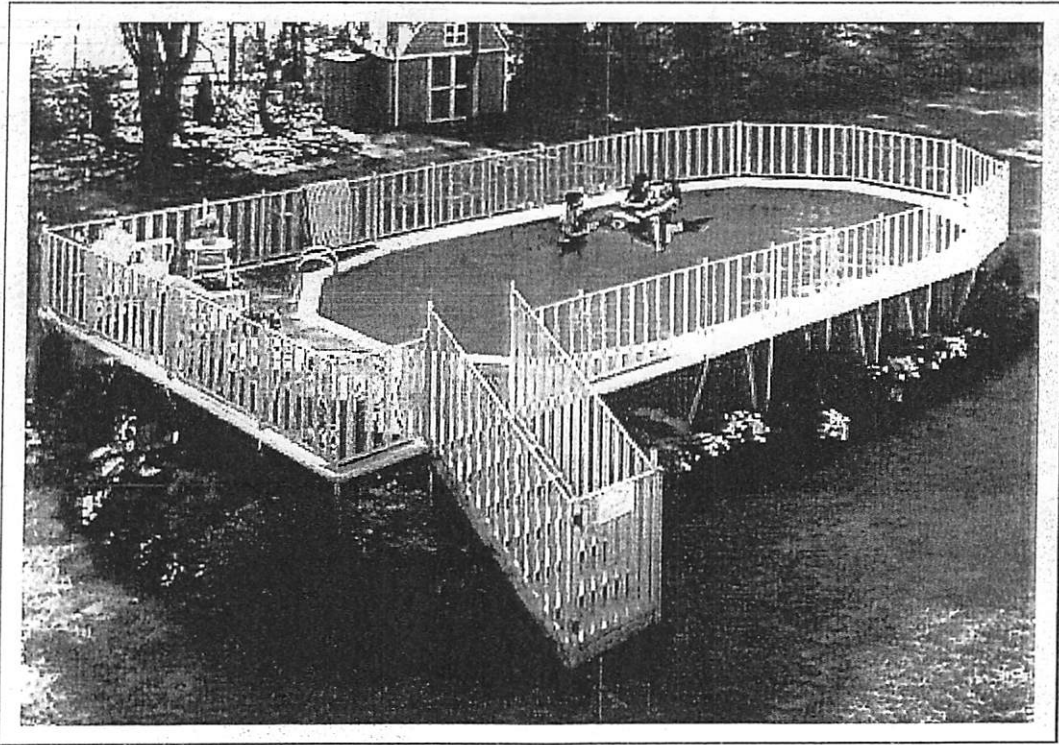

Figure 9

8. Where an above-ground pool on a sloped site that will make a portion of the top of the pool structure to be less than 48" to grade, a minimum of 3-foot level surface around the portion of the pool structure that is less than 48" to grade should be provided. The level surface should be measured away from the pool wall to the excavation edge and should be tapered away from the pool at a minimum of 45-degree angle for a distance of one half the level surface. (Figure 10)

Pool wall acting as barrier on a sloped site

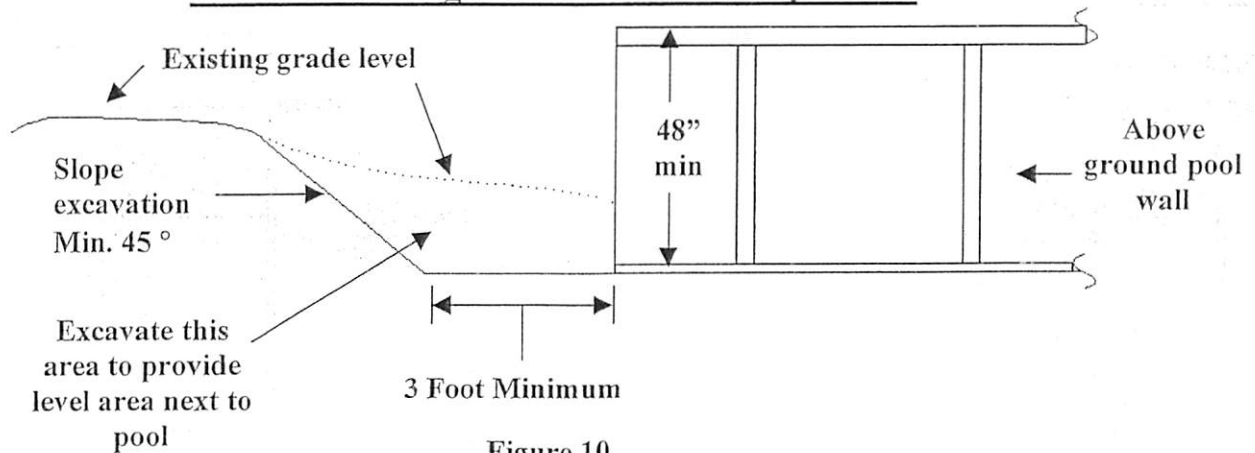

Figure 10

9. For above ground pools, the pool wall may act as the barrier as long as the walls are at least 48" high on the outside of the pool and there is no backfill placed against the pool that would reduce the height of the wall to less than 48".

Decks for Above Ground Pools

If a deck is to be constructed around an above ground pool and there is not another barrier that meets the requirements of items 1 through 8 above, the following must be met:

1. The pool wall must be 48" above grade.
2. Stairs to deck are to have barriers on both sides.
3. There is a gate at the bottom of the stairs that meets the requirements of a barrier above. (Figure 11)

Barriers around Stairs

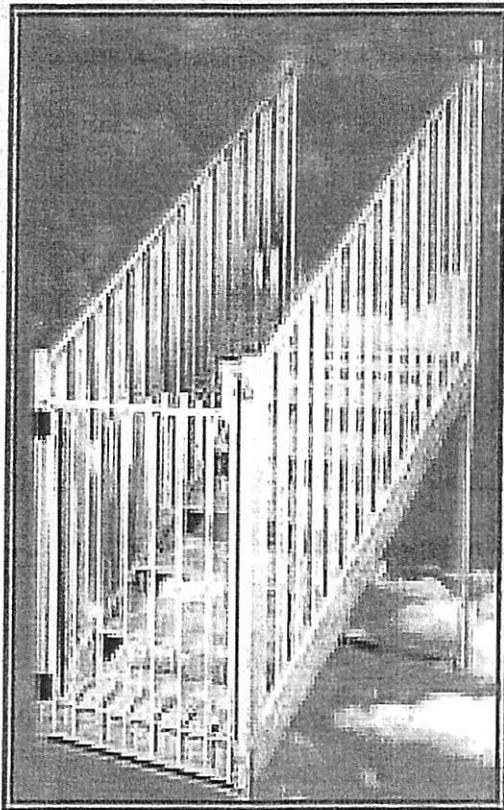

Figure 11

The following applies to all decks around pools whether they are being used as a barrier or not:

4. Footings are required for decks, minimum 30 inches deep.
5. Stairs must be 36" wide, steps are to have a maximum rise of 8 1/4" and a minimum run of 9". (Figure12)

Stair Dimensions Requirements

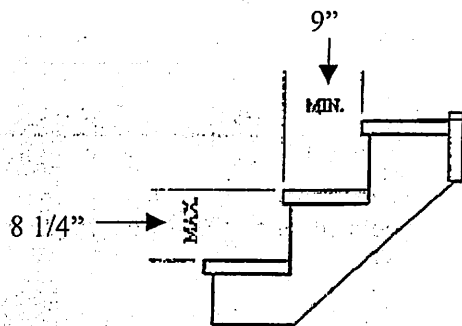
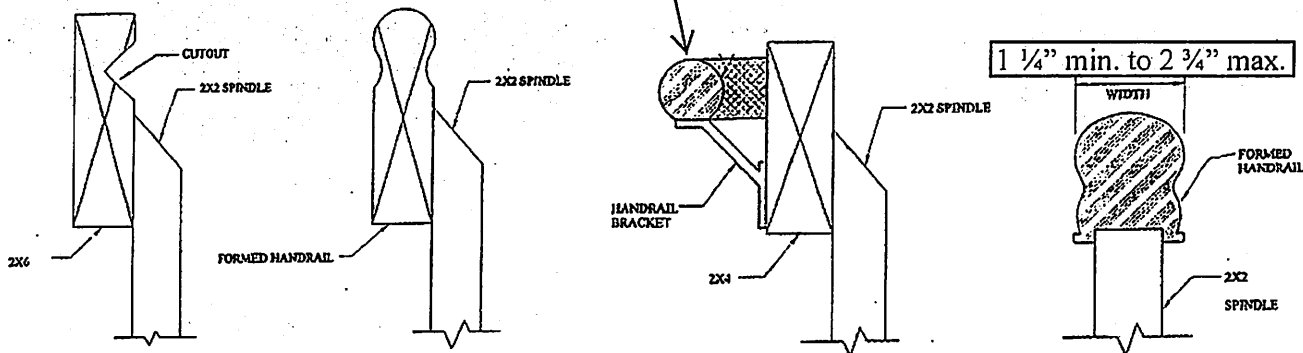

Figure12

7. Stairs must be equal in rise and tread depth to within 3/16".
8. A graspable handrail must be provided on all stairs. The handrail must be mounted 34" to 38" above the stair nosing. (Figure 13)

Example of Graspable Handrails

Handrail with circular 1 1/4 min. to 2 5/8 max. diameter.



Handrails on stairs must be easy graspable. **Note:** A 2x4 or 2x6 mounted on top of the guard is not considered graspable

Figure13

9. A railing is required around any deck more than 30" above grade. The railing must be 36" high, have balusters no more than 4" apart. (Figure 14)

Deck Railing Requirements

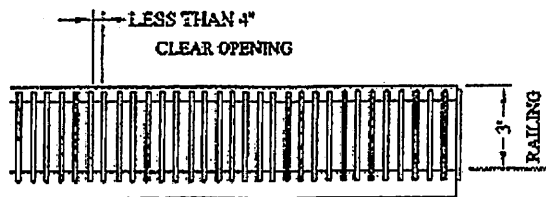

Figure 14

Part I. General Requirements for Pools, Spas, Hot Tubs, and Fountains

Author's Comment:

- The requirements contained in Part I of Article 680 apply to permanently installed pools [680.20], storable pools [680.30], spas and hot tubs [680.42 and 680.43], and fountains [680.50].

680.1 Scope

The requirements contained in Article 680 apply to the installation of electric wiring and equipment for swimming pools, hot tubs, spas, fountains, and hydromassage bathtubs. Figure 680-1

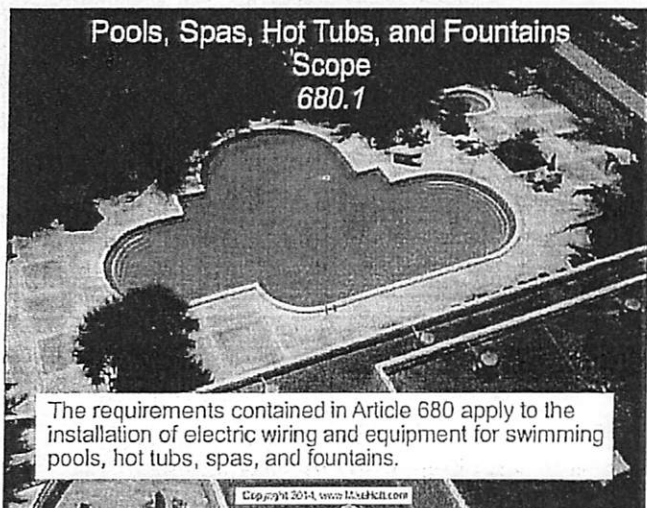

Figure 680-1

680.2 Definitions

Dry-Niche Luminaire. A luminaire intended for installation in the floor or wall of a pool, spa, or fountain in a niche that's sealed against the entry of water.

Forming Shell. A structure mounted in the wall of permanently installed pools, storable pools, outdoor spas, outdoor hot tubs, or fountains designed to support a wet-niche luminaire. Figure 680-2

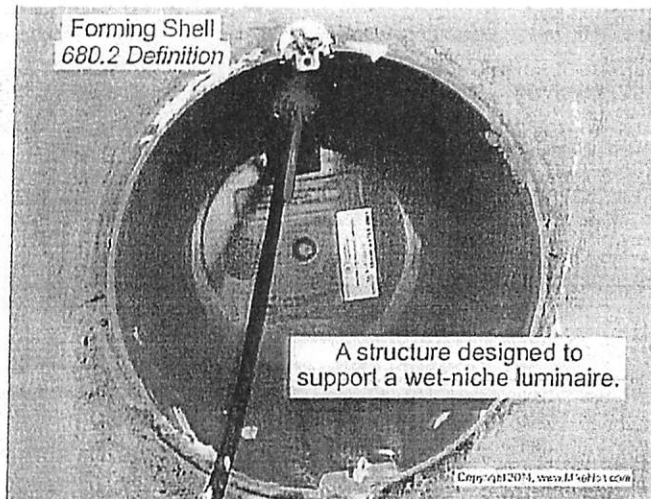

Figure 680-2

Fountain. An ornamental pool, display pool, or reflection pool.

Hydromassage Bathtub. A permanently installed bathtub with a recir-

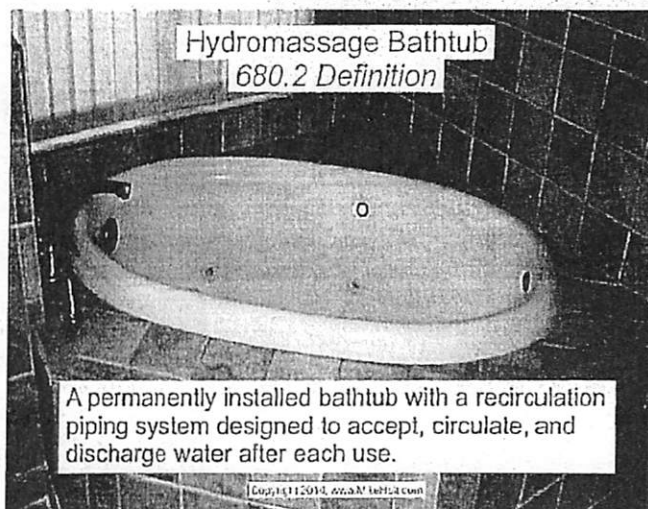

Figure 680-3

culating piping system designed to accept, circulate, and discharge water after each use. Figure 680-3

Low-Voltage Contact Limit. A voltage not exceeding the following values: Figure 680-4

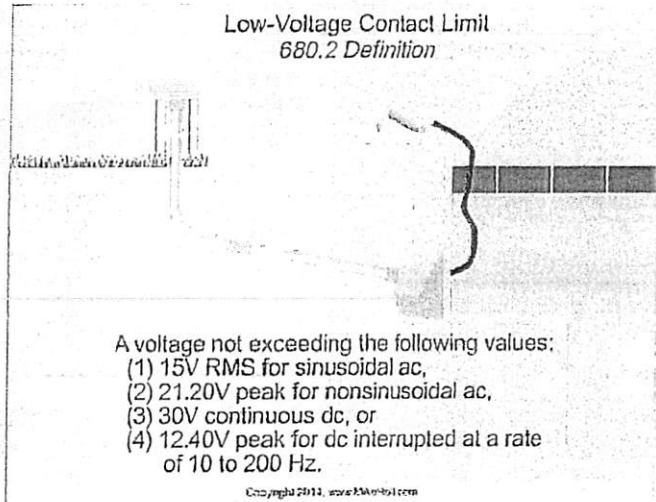

Figure 680-4

- (1) 15V (RMS) for sinusoidal alternating current
- (2) 21.20V peak for nonsinusoidal alternating current
- (3) 30V for continuous direct current
- (4) 12.40V peak for direct current that's interrupted at a rate of 10 to 200 Hz.

Maximum Water Level. The highest level that water reaches before it spills out. Figure 680-5

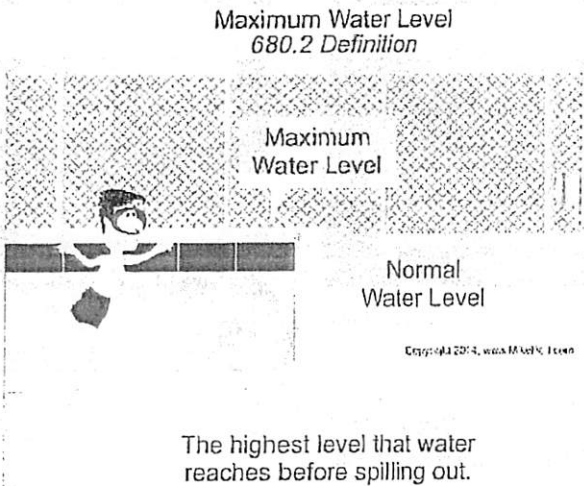

Figure 680-5

Permanently Installed Swimming, Wading, Immersion, and Therapeutic Pools. Those constructed in the ground or partially in the ground, and all others capable of holding water in a depth greater than 42 in., and pools installed inside of a building, regardless of water depth, whether or not served by electrical circuits of any nature. Figure 680-6

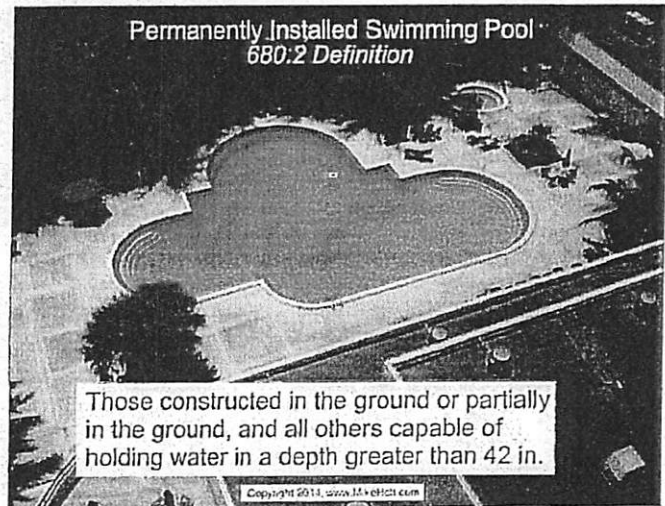

Figure 680-6

Author's Comment:

- The definition of a pool includes baptisteries (immersion pools), which must comply with the requirements of Article 680.

Pool. Manufactured or field-constructed equipment designed to contain water on a permanent or semipermanent basis and used for swimming, wading, immersion, or other purposes.

Spa or Hot Tub. A hydromassage pool or tub designed for recreational or therapeutic use typically not drained after each use. Figure 680-7

Storable Swimming Pool, or Storable/Portable Spas and Hot Tubs. An aboveground pool, or spa, or hot tub with a maximum water depth of 42 in. Figure 680-8

Author's Comment:

- Storable pools are sold as a complete package that consists of the pool walls, vinyl liner, plumbing kit, and pump/filter device. Underwriters Laboratories, Inc. (UL) requires the pump/filter units to have a minimum 25 ft cord to discourage the use of extension cords.

Spa or Hot Tub
680.2 Definition

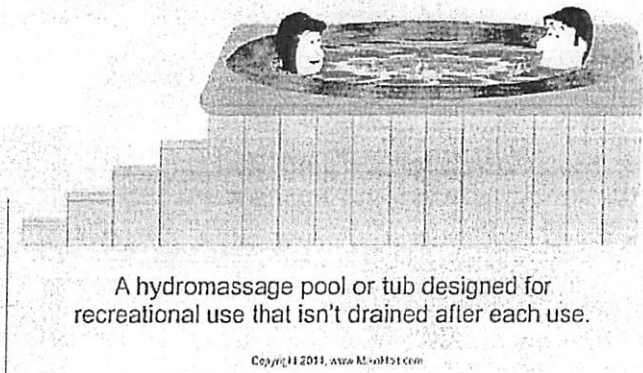

Figure 680-7

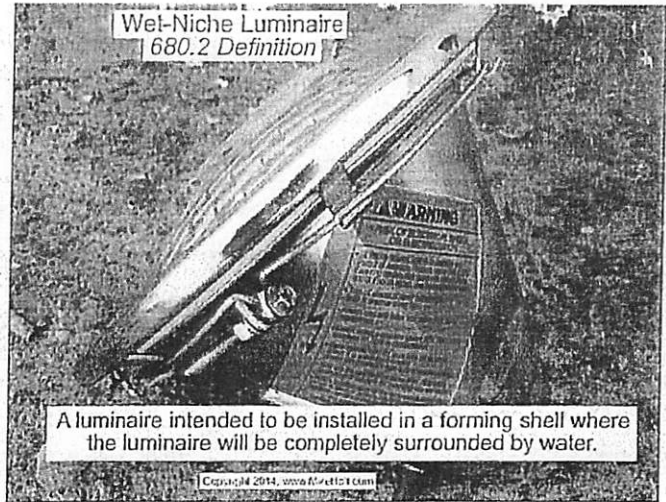

Figure 680-9

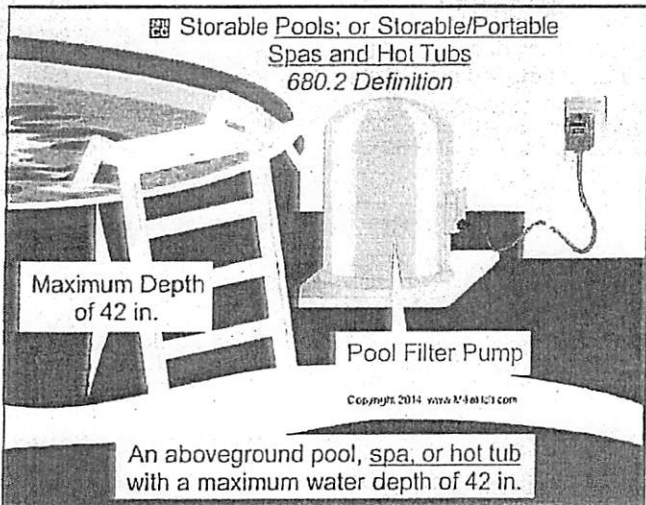

Figure 680-8

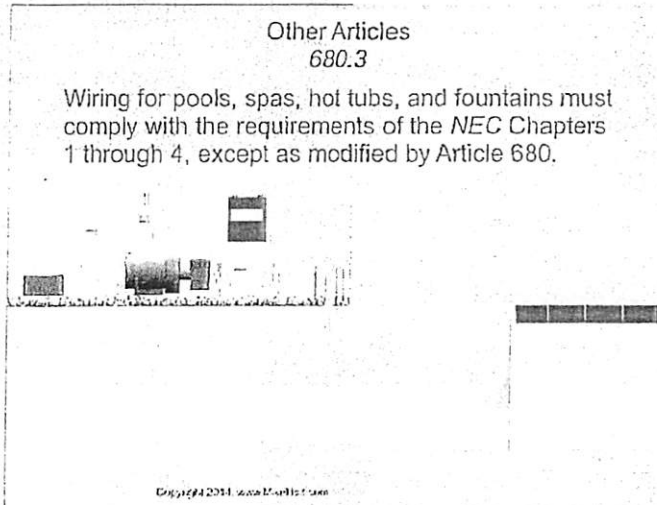

Figure 680-10

Wet-Niche Luminaire. A luminaire intended to be installed in a forming shell where the luminaire will be completely surrounded by water.
Figure 680-9

680.3 Other Articles

The wiring of permanently installed pools, storable pools, spas, hot tubs, or fountains must comply with Chapters 1 through 4, except as modified by this article. Figure 680-10

680.7 Cord-and-Plug-Connected Equipment

Fixed or stationary equipment other than an underwater luminaire for permanently installed pools can be cord-and-plug-connected to facilitate removal or disconnection for maintenance or repair.

(A) **Length.** Except for storable pools, the cord must not exceed 3 ft in length.

Author's Comment:

- The *NEC* doesn't specify a maximum cord length for a storable pool pump motor.

(B) Equipment Grounding Conductor. The cord must have a copper equipment grounding conductor not smaller than 12 AWG and the cord must terminate at a grounding-type attachment plug.

680.8 Overhead Conductor Clearance

Overhead conductors must meet the clearance requirements contained in Table 680.8(A). The clearance is measured from the maximum water level.

(A) Overhead Power Conductors. Permanently installed swimming pools, storable pools, outdoor spas, outdoor hot tubs, fountains, diving structures, observation stands, towers, or platforms near overhead service conductors and other overhead conductors must not be placed within the clearances contained in Table 680.8(A). Figure 680-11

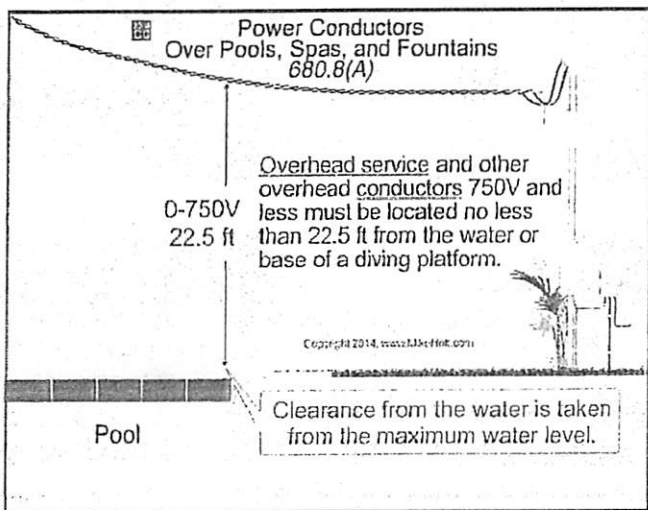

Figure 680-11

Author's Comment:

- This rule doesn't prohibit utility-owned overhead service-drop conductors from being installed over a permanently installed pool, storable pool, outdoor spa, outdoor hot tub, or fountain [90.2(B)(5)]. It does prohibit a permanently installed pool, storable pool, outdoor spa, outdoor hot tub, or fountain from being installed under an existing service drop that isn't at least 22½ ft above the water.

(B) Communications Systems. Permanently installed pools, storable pools, outdoor spas, outdoor hot tubs, fountains, diving structures, observation stands, towers, or platforms must not be placed under, or within, 10 ft of communications cables. Figure 680-12

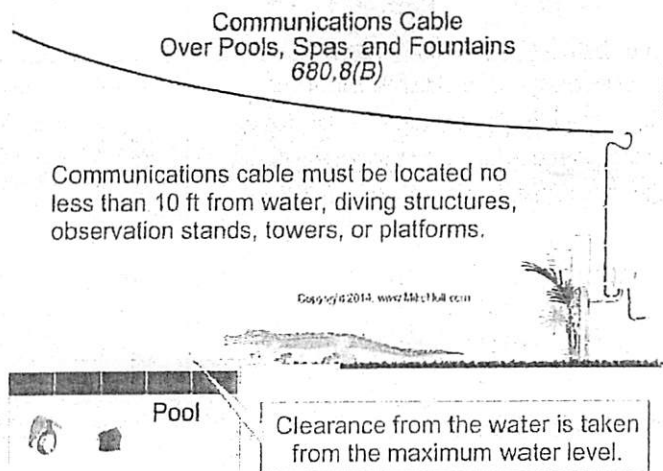

Figure 680-12

Author's Comment:

- This rule doesn't prohibit a utility-owned communications overhead cable from being installed over a permanently installed pool, storable pool, outdoor spa, outdoor hot tub, or fountain [90.2(B)(4)]. It does prohibit a permanently installed pool, storable pool, outdoor spa, outdoor hot tub, or fountain from being installed under an existing communications utility overhead supply that isn't at least 10 ft above the water.

680.9 Electric Water Heaters

The ampacity of branch-circuit conductors and overcurrent devices for pool or outdoor spa and hot tub water heaters must not be less than 125 percent of the total nameplate rating. Figure 680-13

Electric Pool Water Heaters
680.9

The ampacity of branch-circuit conductors and overcurrent protective devices for pool or outdoor spa and hot tub water heaters can't be less than 125 percent of the total nameplate rating.

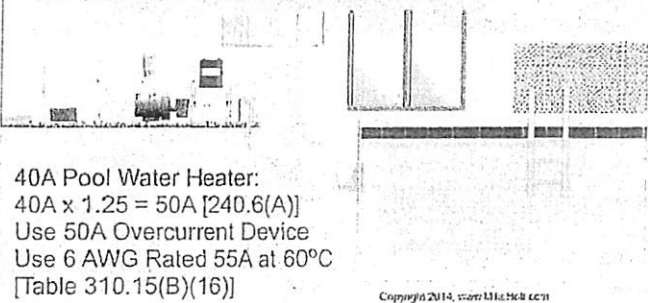

Figure 680-13

680.10 Underground Wiring

Underground wiring isn't permitted under permanently installed pools or within 5 ft horizontally from the inside wall of the pool unless necessary to supply the permanently installed pool or storable pool equipment. Figure 680-14

If space limitations prevent underground wiring from being at least 5 ft away, wiring must be installed in complete raceway systems of rigid metal conduit, intermediate metal conduit, or PVC conduit. Figure 680-15

The minimum cover is 6 in. for rigid metal conduit and intermediate metal conduit. Nonmetallic raceways must have at least 6 in. of cover, 4 in. of which must be concrete. Nonmetallic raceways listed for direct burial without concrete encasement require 18 in. of cover [Table 680.10].

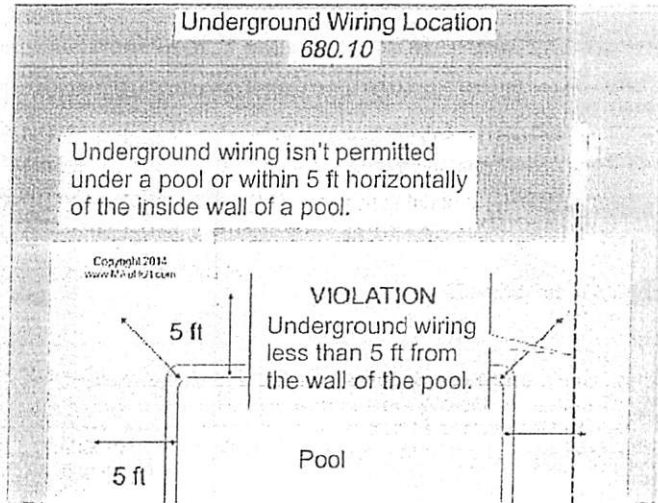

Figure 680-14

Underground Wiring
Space Limitations
680.10

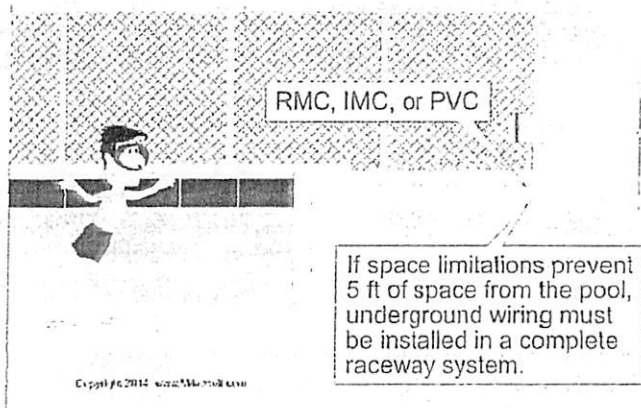

Figure 680-15

680.11 Equipment Rooms and Pits

Permanently installed pool, storable pool, outdoor spa, outdoor hot tub, or fountain equipment must not be located in rooms or pits that don't have drainage that prevents water accumulation during normal operation or filter maintenance. Figure 680-16

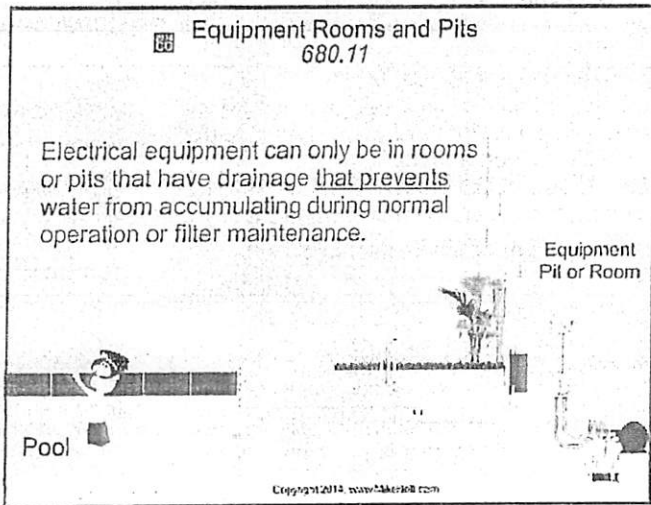

Figure 680-16

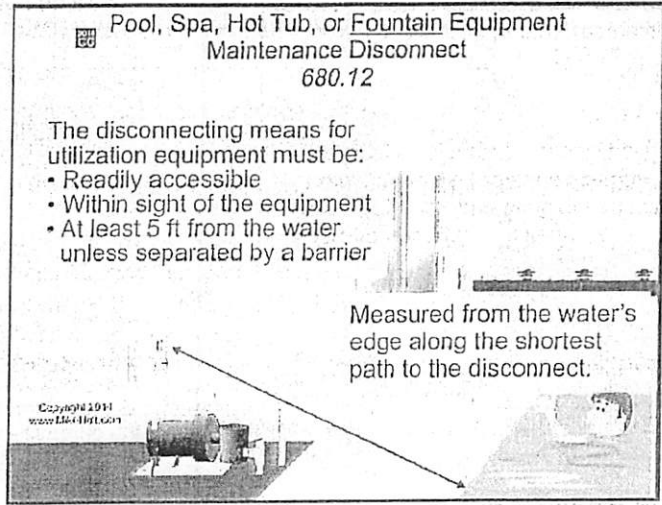

Figure 680-17

680.12 Maintenance Disconnecting Means

A maintenance disconnecting means is required for the permanently installed pool, storable pool, outdoor spa, outdoor hot tub, or fountain equipment, other than lighting, for these water bodies.

The maintenance disconnecting means must be readily accessible and located within sight and at least 5 ft from the permanently installed pool, storable pool, outdoor spa, outdoor hot tub, or fountain equipment unless separated from the open water by a permanently installed barrier that provides a 5-foot reach path or greater. This horizontal distance is measured from the water's edge along the shortest path required to reach the disconnecting means. Figure 680-17

Author's Comment:

- According to Article 100, "within sight" means that it's visible and not more than 50 ft from one to the other.

Part II. Permanently Installed Pools, Outdoor Spas, and Outdoor Hot Tubs

680.20 General

The installation requirements contained in Part I and Part II apply to permanently installed pools [680.20], spas, and hot tubs [680.42 and 680.43].

680.21 Motors

(A) **Wiring Methods.** The wiring to a motor must comply with (A)(1) unless modified by (A)(2), (A)(3), (A)(4), or (A)(5). Figure 680-18

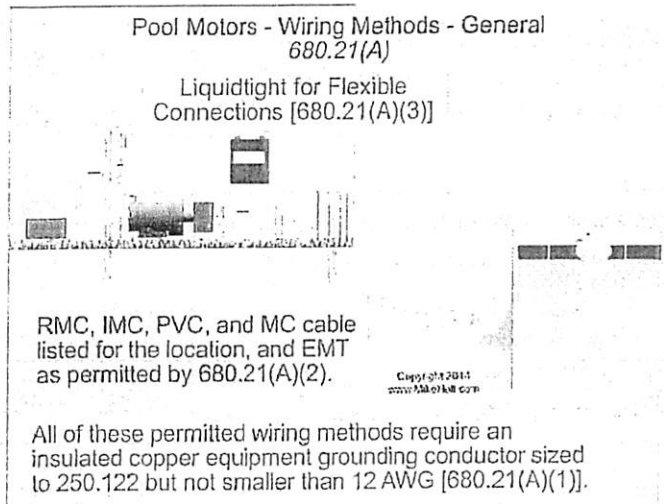

Figure 680-18

(1) **General.** Branch-circuit conductors for permanently installed pool, outdoor spa, and outdoor hot tub motors must be installed in rigid metal conduit, intermediate metal conduit, PVC conduit, or Type MC cable listed for the location (sunlight-resistant or for direct burial). The wiring methods must contain an insulated copper equipment grounding conductor sized in accordance with 250.122, based on the rating of the overcurrent device, but in no case can it be smaller than 12 AWG.

(2) **On or Within Buildings.** EMT can be installed on or within buildings.

Author's Comment:

- If electrical metallic tubing is used, it must contain an insulated copper equipment grounding conductor as required by 680.21(A)(1).

(3) **Flexible Connections.** Liquidtight flexible metal or liquidtight flexible nonmetallic conduit is permitted, however it must contain an insulated copper equipment grounding conductor as required by 680.21(A)(1).

(4) **One-Family Dwelling.** Any Chapter 3 wiring method can be used on the interior of a one-family dwelling unit or accessory building associated with the dwelling unit. Raceways must contain an insulated copper equipment grounding conductor as required by 680.21(A)(1), and cable assemblies can utilize an uninsulated copper equipment grounding conductor but it must be enclosed by the outer sheath of the cable assembly. Figure 680-19

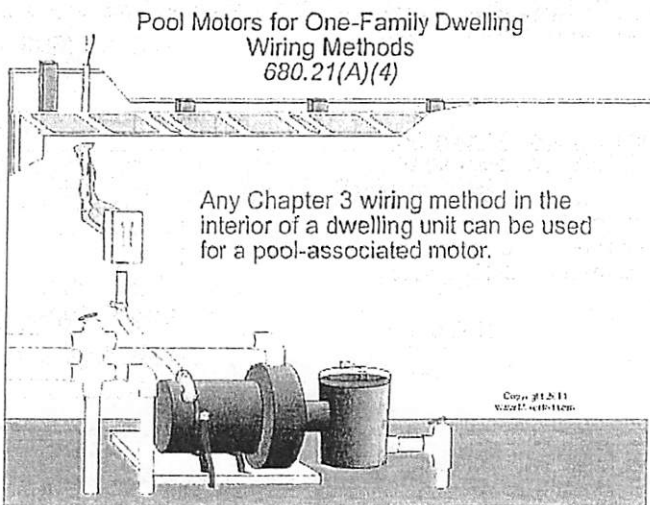

Figure 680-19

(5) **Cord-and-Plug Connections.** Cords are permitted if the length doesn't exceed 3 ft and it contains a copper equipment grounding conductor, sized in accordance with 250.122, based on the rating of the overcurrent device, but not smaller than 12 AWG. Figure 680-20

Pool Motors
Cord-and-Plug Connected
680.21(A)(5)



A cord no longer than 3 ft with an attachment plug and containing a copper equipment grounding conductor not smaller than 12 AWG is permitted for pool motors.

Copyright 2014 www.MikeHolt.com

Figure 680-20

Author's Comment:

- For outdoor spas and hot tubs, the cord must be GFCI protected and it can be up to 15 ft long [680.42(A)(2)].

(C) **GFCI Protection.** GFCI protection is required for outlets supplying pool pump motors connected to single-phase, 120V through 240V branch circuits, whether by receptacle or by direct connection. Figure 680-21

680.22 Lighting, Receptacles, and Equipment

(A) **Receptacles.**

(1) **Required Receptacle Location.** One 15A or 20A, 125V receptacle must be located not less than 6 ft and not more than 20 ft from the inside wall of a permanently installed pool, outdoor spa, or outdoor hot tub. This receptacle must be located not more than 6½ ft above the floor, platform, or grade level serving the permanently installed pool, outdoor spa, or outdoor hot tub. Figure 680-22

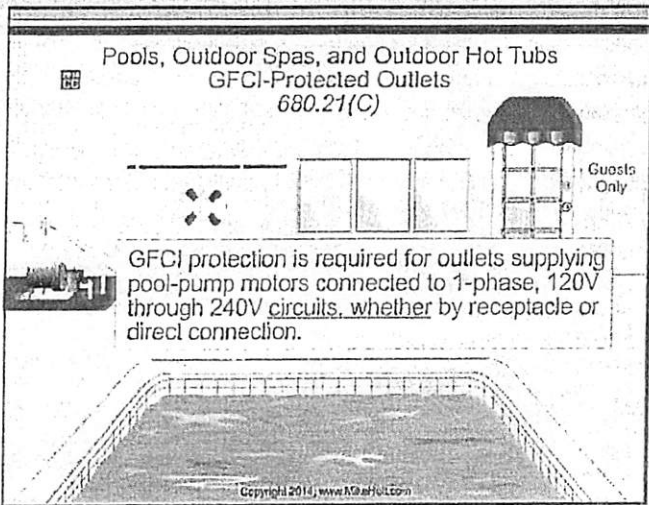

Figure 680-21

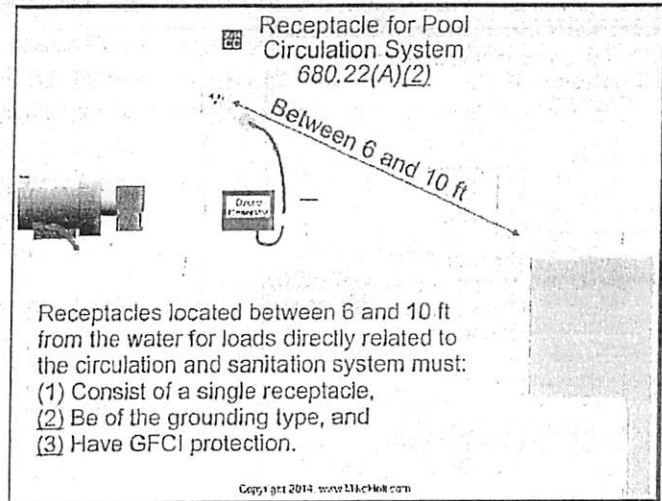

Figure 680-23

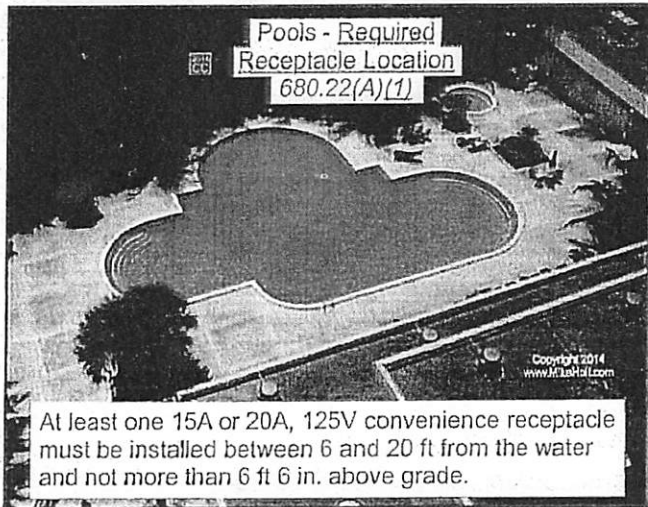

Figure 680-22

(2) Circulation System. Receptacles for permanently installed pool, outdoor spa, and outdoor hot tub motors, or other loads directly related to the circulation system must be located not less than 10 ft from the inside walls of a permanently installed pool, outdoor spa, or outdoor hot tub, or not less than 6 ft from the inside walls of a permanently installed pool, outdoor spa, or outdoor hot tub if they meet all of the following conditions: Figure 680-23

- (1) Consist of a single receptacle
- (2) Be of the grounding type
- (3) Have GFCI protection

(3) Other Receptacles. Receptacles not for motors or other loads directly related to the circulation system must be not less than 6 ft from the inside walls of a permanently installed pool, outdoor spa, or outdoor hot tub. Figure 680-24

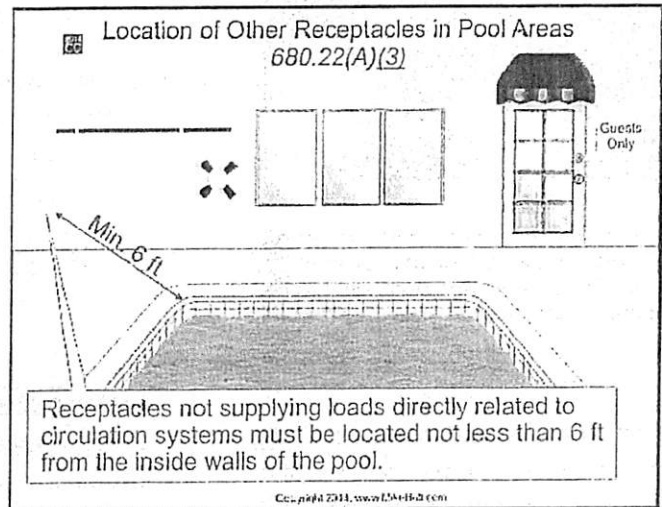

Figure 680-24

(4) GFCI-Protected Receptacles. 15A and 20A, 125V receptacles located within 20 ft from the inside walls of a permanently installed pool, outdoor spa, or outdoor hot tub must be GFCI protected. Figure 680-25

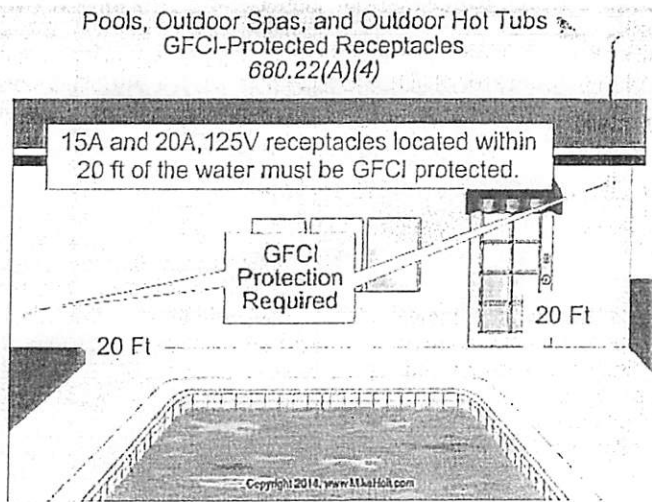

Figure 680-25

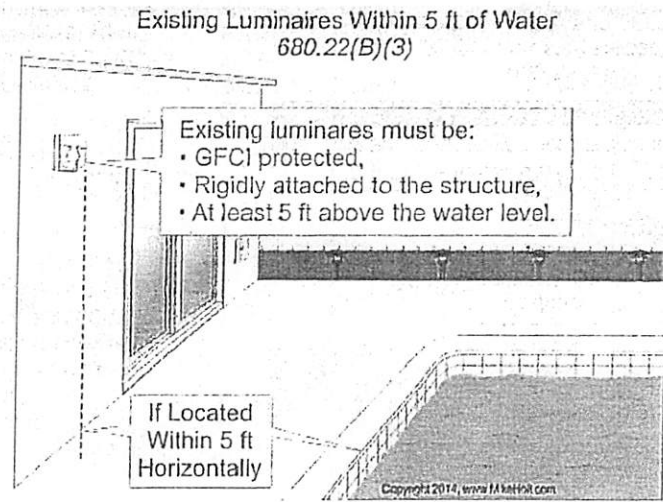

Figure 680-26

Author's Comment:

- Outdoor dwelling unit receptacles must be GFCI protected, regardless of the distance from a permanently installed pool, spa, or hot tub [210.8(A)(3)].
- All 15A and 20A, 125V receptacles for nondwelling units located outdoors require GFCI protection [210.8(B)(4)].

(5) Measurements. The receptacle distance is measured as the shortest path an appliance cord would follow without passing through a wall, doorway, or window.

(B) Luminaires and Ceiling Fans.

(1) New Outdoor Installations. Luminaires and ceiling fans installed above the water, or the area extending within 5 ft horizontally from the inside walls of a permanently installed pool, outdoor spa, or outdoor hot tub, must not be less than 12 ft above the maximum water level.

(3) Existing Installations. Existing luminaires located less than 5 ft horizontally from the inside walls of a permanently installed pool, outdoor spa, or outdoor hot tub must be not less than 5 ft above the surface of the maximum water level, must be rigidly attached to the existing structure, and must be GFCI protected. Figure 680-26

(4) Adjacent Areas. New luminaires installed between 5 ft and 10 ft horizontally from the inside walls of a permanently installed pool, outdoor spa, or outdoor hot tub must be GFCI protected, unless installed not less than 5 ft above the maximum water level and rigidly attached to the existing structure adjacent to or enclosing the permanently installed pool, outdoor spa, or outdoor hot tub.

(6) Low-Voltage Luminaires. Listed luminaires that don't require grounding, and that meet the low-voltage contact limit, can be less than 5 ft from the inside walls of the pool. Figure 680-27

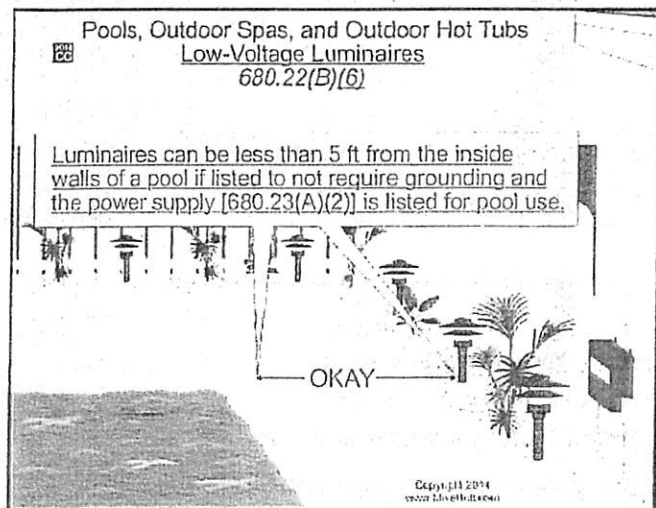

Figure 680-27

Author's Comment:

- The Low-Voltage Contact Limit is defined in 680.2.

(C) **Switching Devices.** Circuit breakers, time clocks, pool light switches, and other switching devices must be located not less than 5 ft horizontally from the inside walls of a permanently installed pool, outdoor spa, or outdoor hot tub unless separated by a solid fence, wall, or other permanent barrier, unless the switching device is listed as being acceptable for use within 5 ft. Figure 680-28

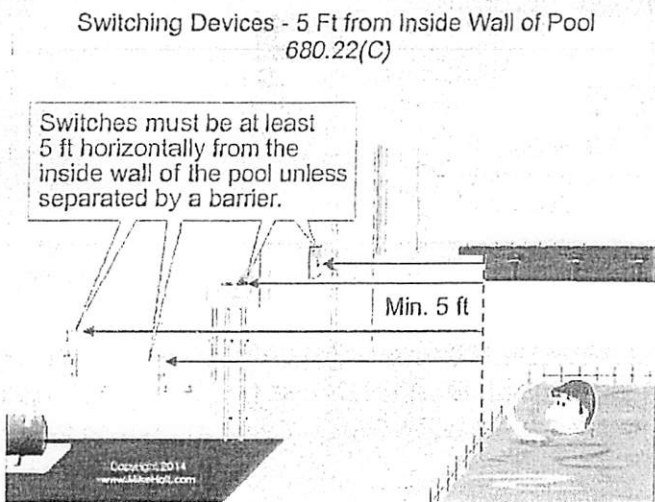

Figure 680-28

(D) **Other Outlets.** Other outlets must not be located less than 10 ft from the inside walls of a permanently installed pool, outdoor spa, or outdoor hot tub. The receptacle distance is measured as the shortest path an appliance cord would follow without passing through a wall, doorway, or window [680.22(A)(5)].

Note: Examples of other outlets may include remote-control, signaling, fire alarm, and communications circuits.

680.23 Underwater Luminaires

(A) General.

(2) **Transformers and Power Supplies.** Transformers and power supplies for underwater luminaires must be listed.

(3) **GFCI Protection of Underwater Luminaires, Relamping.** Branch circuits that supply underwater luminaires operating at more than 15V for sinusoidal alternating current, 21.20V peak for nonsinusoidal alternating current, 30V for continuous direct current, and 12.40V peak for direct current interrupted at a rate of 10 to 200 Hz or less [680.2 Low-Voltage Contact Limit] must be GFCI protected. Figure 680-29

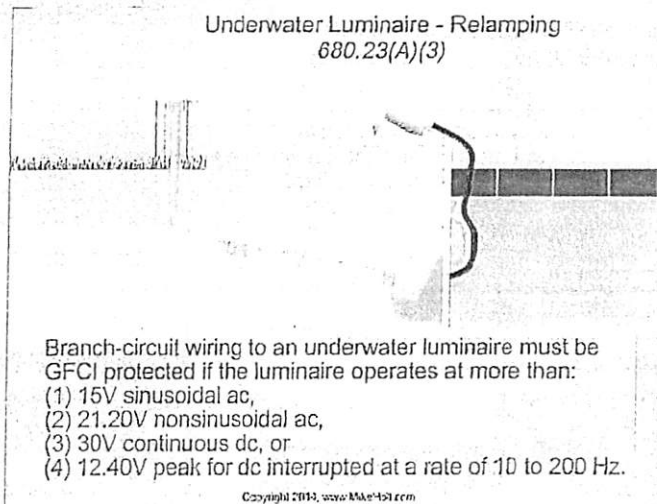

Figure 680-29

(5) **Wall-Mounted Luminaires.** Underwater luminaires must be installed so that the top of the luminaire lens isn't less than 18 in. below the normal water level. Figure 680-30

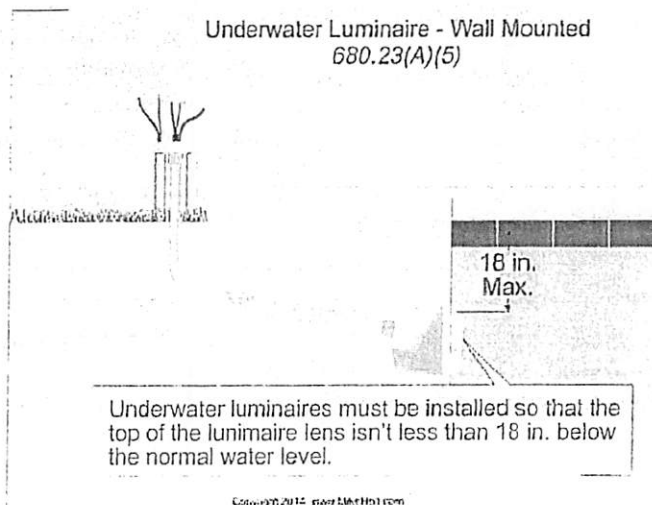

Figure 680-30

(B) Wet-Niche Underwater Luminaires.

(1) Forming Shells. Forming shells for wet-niche underwater luminaires must be equipped with provisions for raceway entries. All forming shells used with PVC conduit systems must include provisions for terminating an 8 AWG copper conductor.

(2) Wiring to the Forming Shell. The raceway that extends directly to the underwater pool wet-niche forming shell must comply with (a) or (b).

(a) Metal Raceway. Brass or corrosion-resistant rigid metal conduit approved by the authority having jurisdiction.

(b) Nonmetallic Raceway. A nonmetallic raceway to the forming shell must contain an 8 AWG insulated (solid or stranded) copper bonding jumper that terminates to the forming shell and junction box. Figure 680-31

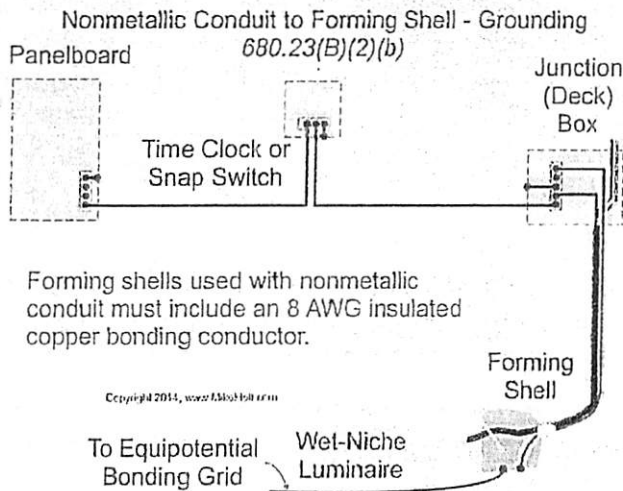

Figure 680-31

The termination of the 8 AWG bonding jumper in the forming shell must be covered with a listed potting compound to protect the connection from the possible deteriorating effects of pool water.

(6) Servicing. The forming shell location and length of cord in the forming shell must allow for personnel to place the removed luminaire on the deck or other dry location for maintenance. The luminaire maintenance location must be accessible without entering or going in the pool water. Figure 680-32

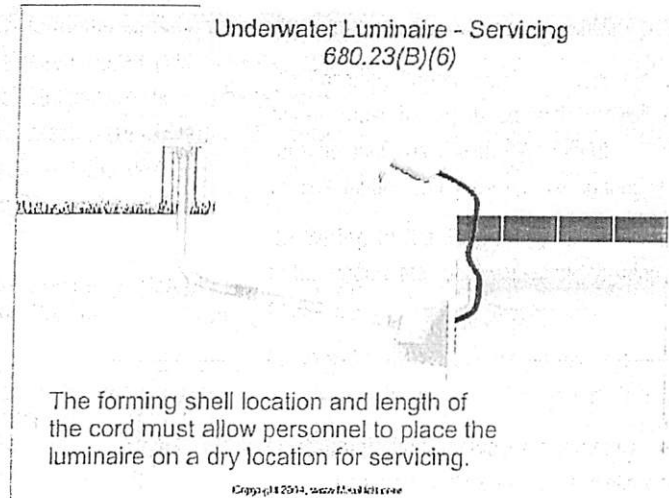

Figure 680-32

Author's Comment:

- While it may be necessary to enter the pool water, possibly with underwater breathing apparatus in some cases, the cord must be long enough to allow the luminaire to be brought out and placed on a deck or other dry location where the relamping, maintenance, or inspection can take place without entering the pool water.

(F) Branch-Circuit Wiring.

(1) Wiring Methods. Branch-circuit wiring for underwater luminaires must be contained in rigid metal conduit, intermediate metal conduit, liquidtight flexible nonmetallic conduit, or PVC conduit [680.23(B)(2)].

Electrical metallic tubing is permitted to be installed on buildings and electrical nonmetallic tubing, Type MC cable, electrical metallic tubing, or Type AC cable is permitted to be installed within buildings. These wiring methods must contain an insulated copper equipment grounding conductor sized in accordance with Table 250.122, based on the rating of the overcurrent device, but in no case can it be smaller than 12 AWG.

Ex: If connecting to transformers for pool lights, liquidtight flexible metal conduit is permitted in individual lengths not exceeding 6 ft.

(2) Equipment Grounding Conductor. For other than listed low-voltage luminaires not requiring grounding, branch-circuit conductors for an underwater luminaire must contain an insulated copper equipment grounding conductor sized in accordance with Table 250.122, based on the rating of the overcurrent device, but not smaller than 12 AWG. Figure 680-33

Pool Light - Equipment Grounding Conductor
680.23(F)(2)

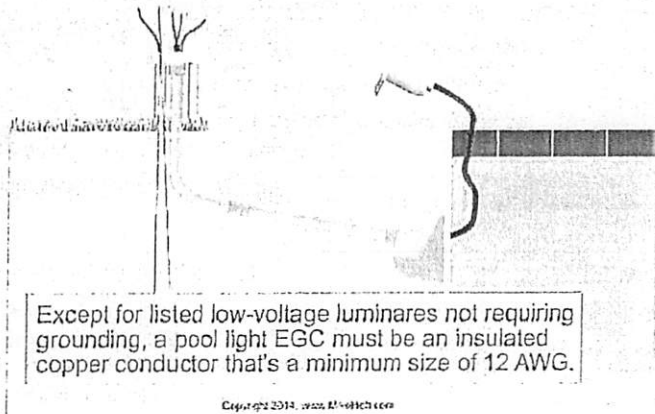

Figure 680-33

The circuit equipment grounding conductor for the underwater luminaire must not be spliced, except as permitted in (a) or (b).

- (a) If more than one underwater luminaire is supplied by the same branch circuit, the circuit equipment grounding conductor can terminate at a listed pool junction box that meets the requirements of 680.24(A).
- (b) The circuit equipment grounding conductor can terminate at the grounding terminal of a listed pool transformer that meets the requirements of 680.23(A)(2).

(3) Conductors. The branch-circuit conductors on the load side of a GFCI or transformer for underwater luminaires must not occupy raceways or enclosures containing other conductors unless one of the following conditions applies:

- (1) The other conductors are GFCI protected.
- (2) The other conductors are equipment grounding conductors.
- (3) The other conductors are the supply conductors to a feed-through type GFCI.
- (4) The GFCI-protected conductors are within a panelboard.

680.24 Junction Box, Transformer, or GFCI Enclosure

(A) Junction Box. The junction box (deck box) that connects directly to an underwater permanently installed pool, outdoor spa, or outdoor hot tub luminaire forming shell must comply with the following:

(1) Construction. The junction box must be listed as a swimming pool junction box, and must be: Figure 680-34

Junction Box for Underwater Luminaire
680.24(A)(1)

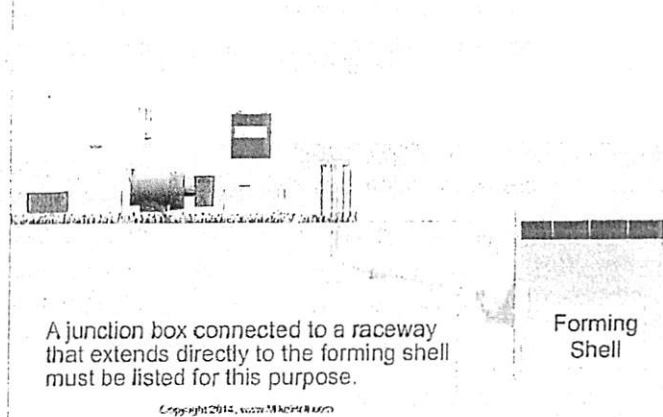

Figure 680-34

- (1) Equipped with threaded entries or a nonmetallic hub,
- (2) Constructed of copper, brass, or corrosion-resistant material approved by the authority having jurisdiction, and
- (3) Provide electrical continuity between metal raceways and grounding terminals within the junction box.

Author's Comment:

- In addition, the junction box must be provided with at least one grounding terminal more than the number of raceway entries [680.24(D)], and the junction box must have a strain relief for the cord [680.24(E)].

(2) **Installation.** If the luminaire operates at over 15V for sinusoidal alternating current, 21.20V peak for nonsinusoidal alternating current, 30V for continuous direct current, or 12.40V peak for direct current interrupted at a rate of 10 to 200 Hz [680.2 Low-Voltage Contact Limit], the junction box location must comply with (a) and (b). If the luminaire operates at 15V for sinusoidal alternating current, 21.20V peak for nonsinusoidal alternating current, 30V for continuous direct current, or 12.40V peak for direct current interrupted at a rate of 10 to 200 Hz or less [680.2 Low-Voltage Contact Limit], the junction box location is permitted to comply with (c).

(a) **Vertical Spacing.** The junction box must be located not less than 4 in. above the ground or permanently installed pool deck, outdoor spa deck, or outdoor hot tub deck, or not less than 8 in. above the maximum water level, whichever provides the greater elevation. Figure 680-35

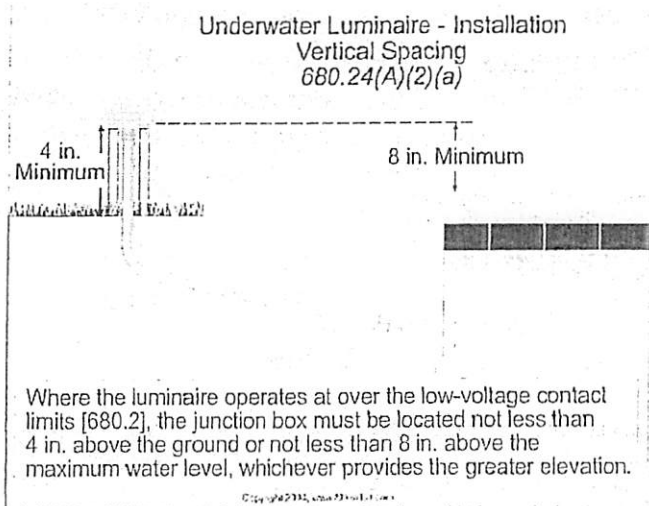

Figure 680-35

(b) **Horizontal Spacing.** The junction box must be located not less than 4 ft from the inside wall of the permanently installed pool, outdoor spa, or outdoor hot tub, unless separated by a solid fence, wall, or other permanent barrier. Figure 680-36

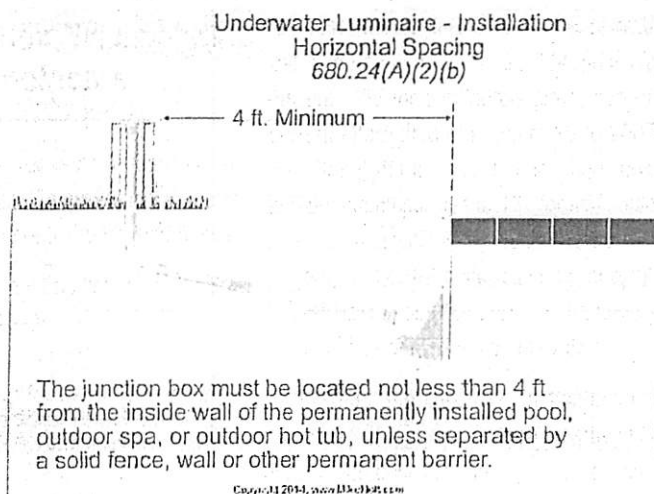

Figure 680-36

(c) **Flush Deck Box.** For a lighting system operating at 15V for sinusoidal alternating current, 21.20V peak for nonsinusoidal alternating current, 30V for continuous direct current, or 12.40V peak for direct current interrupted at a rate of 10 to 200 Hz or less [680.2 Low-Voltage Contact Limit], a flush deck box is permitted if both of the following apply:

- (1) An approved potting compound prevents the entrance of moisture.
- (2) The flush deck box is located not less than 4 ft from the inside wall of the pool.

(B) **Transformer or GFCI Enclosure.** If the enclosure for a transformer or GFCI is connected to a raceway that extends directly to an underwater permanently installed pool, outdoor spa, or outdoor hot tub luminaire forming shell, the enclosure must comply with the following:

(1) **Construction.** The enclosure must be listed and labeled for the purpose, and be:

- (1) Equipped with threaded entries or a nonmetallic hub,
- (2) Constructed of copper, brass, or corrosion-resistant material approved by the authority having jurisdiction, and
- (4) Provided with electrical continuity between metal raceways and the grounding terminals of the enclosure.

Author's Comment:

- See the definitions of "Labeled" and "Listed" in Article 100.

Author's Comment:

- The junction box must be supported by two metal conduits threaded wrenchtight into the enclosure according to 314.23(E).

(C) **Physical Protection.** Junction boxes for underwater pool, spa, or hot tub luminaires that are mounted above the grade of the surrounding finished walkway must not be located in the walkway unless afforded protection by being located under diving boards or adjacent to fixed structures.

(D) **Equipment Grounding Terminals.** The junction box for an underwater permanently installed pool, outdoor spa, or outdoor hot tub luminaire must be provided with at least one more grounding terminal than the number of raceway entries.

Author's Comment:

- Typically, there are four grounding terminals in the junction box and three raceway entries.

(E) **Strain Relief.** The termination of a flexible cord that supplies an underwater permanently installed pool, outdoor spa, or outdoor hot tub luminaire must be provided with a strain relief.

(F) **Grounding.** The metal parts of a junction box, transformer enclosure, or other enclosure in the supply circuit to a wet-niche luminaire must be connected to the equipment grounding terminal of the supplied circuit panelboard. Figure 680-37

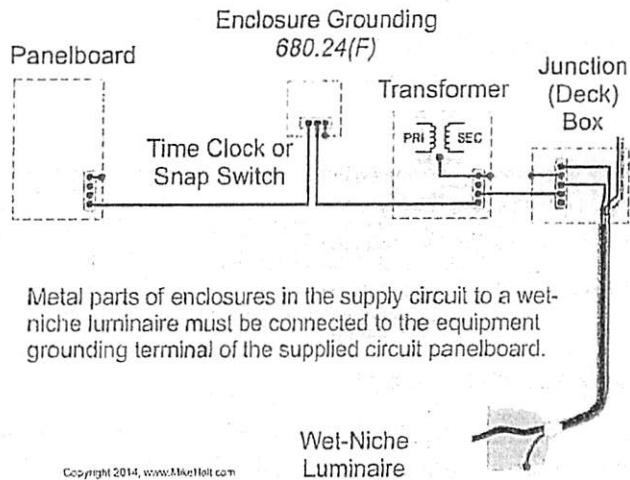

Figure 680-37

680.25 Feeders

(A) Wiring Methods.

(1) **Feeders.** Feeder conductors to panelboards containing permanently installed pool, outdoor spa, or outdoor hot tub equipment circuits must be installed in rigid metal conduit or intermediate metal conduit. If not subject to physical damage, the following wiring methods are permitted: Figure 680-38

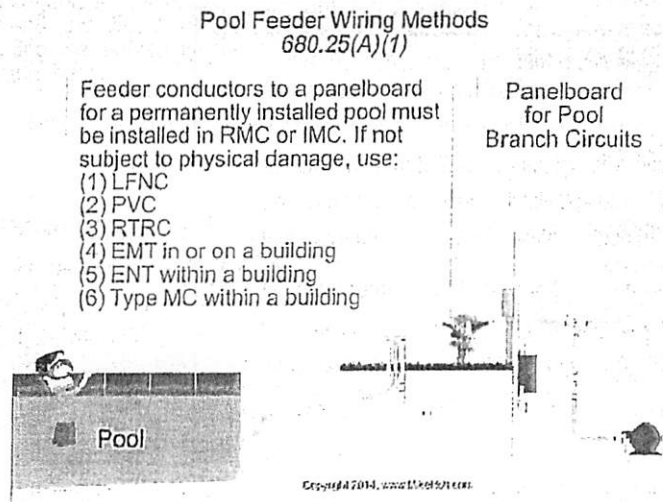

Figure 680-38



Scan the QR code for a video clip of Mike explaining this topic; this is a sample from the DVDs that accompany this textbook.

- (1) Liquidtight flexible nonmetallic conduit
- (2) PVC conduit
- (4) Electrical metallic tubing where installed on or within a building
- (5) Electrical nonmetallic tubing where installed within a building
- (6) Type MC cable where installed within a building and not subject to a corrosive environment

Ex: A feeder conductor within a one-family dwelling unit or two-family dwelling unit between a remote panelboard and service equipment can be contained in a cable that contains an insulated equipment grounding conductor.

(B) Equipment Grounding Conductor. An insulated (copper or aluminum) equipment grounding conductor must be installed with the feeder conductors between the grounding terminal of the pool, outdoor spa, or outdoor hot tub equipment panelboard and the grounding terminal of service equipment.

(1) Size. This feeder equipment grounding conductor must be sized in accordance with 250.122, based on the rating of the overcurrent device, but not smaller than 12 AWG.

(2) Separate Buildings. If a feeder is run to a separate building panelboard that supplies permanently installed swimming pool, outdoor spa, or outdoor hot tub equipment, an insulated equipment grounding conductor must be installed with the feeder conductors [250.32(B)].

680.26 Equipotential Bonding

Author's Comment:

- The bonding requirements of this section don't apply to spas and hot tubs [680.42]

(A) Performance. The required equipotential bonding is intended to reduce voltage gradients in the area around a permanently installed pool. Figure 680-39

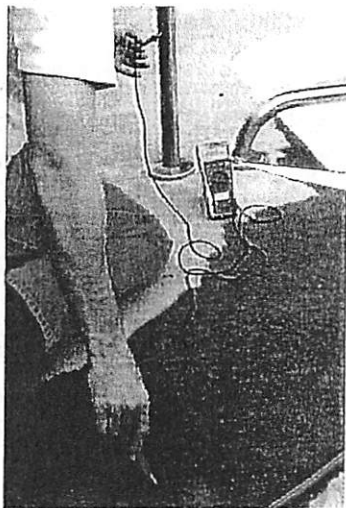

Equipotential Bonding Performance 680.26(A)



Equipotential bonding is intended to reduce voltage gradients in the pool area.

Copyright 2014, www.MikeHolt.com

Figure 680-39



Scan the QR code for a video clip of Mike explaining this topic; this is a sample from the DVDs that accompany this textbook.

(B) Bonded Parts. The parts of a permanently installed pool listed in (B)(1) through (B)(7) must be bonded together with a solid copper conductor not smaller than 8 AWG with listed pressure connectors, terminal bars, exothermic welding, or other listed means in accordance with 250.8(A). Figure 680-40

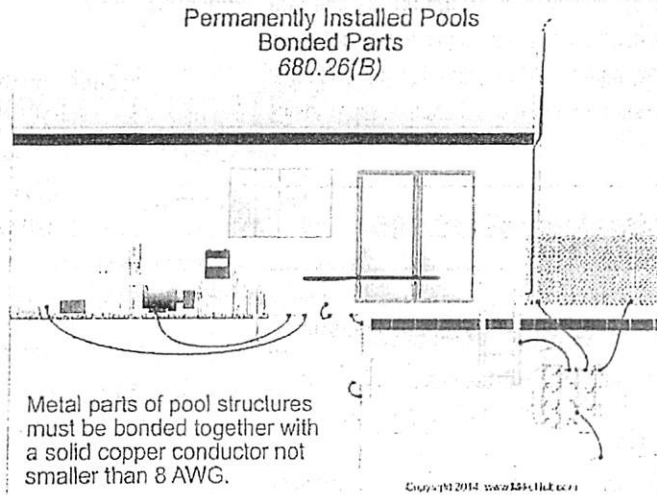

Figure 680-40

Equipotential bonding isn't required to extend to or be attached to any panelboard, service equipment, or grounding electrode.

(1) Concrete Pool Shells-Equipotential Bonding.

(a) Structural Reinforcing Steel. Unencapsulated structural reinforcing steel in concrete shells must be bonded together by steel tie wires. Figure 680-41

(2) Perimeter Surfaces. Equipotential bonding must extend 3 ft horizontally beyond the inside walls of a pool including unpaved, paved, and poured concrete surfaces. Figure 680-42

Author's Comment:

- The *NEC* doesn't provide any guidance on the installation requirements for structural reinforcing steel when used as a perimeter equipotential bonding method.

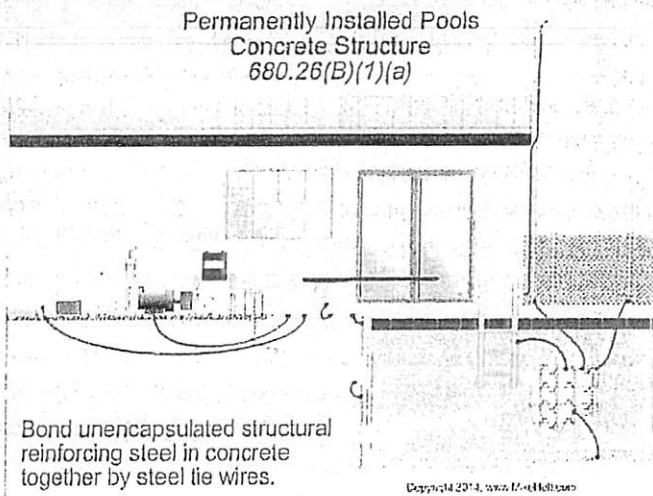

Figure 680-41

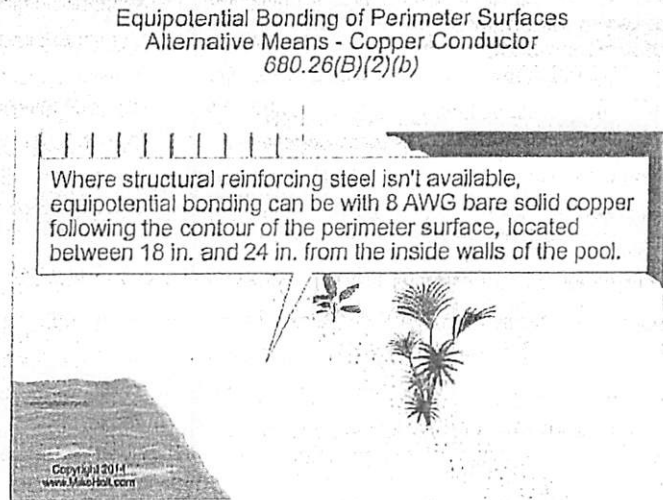

Figure 680-43

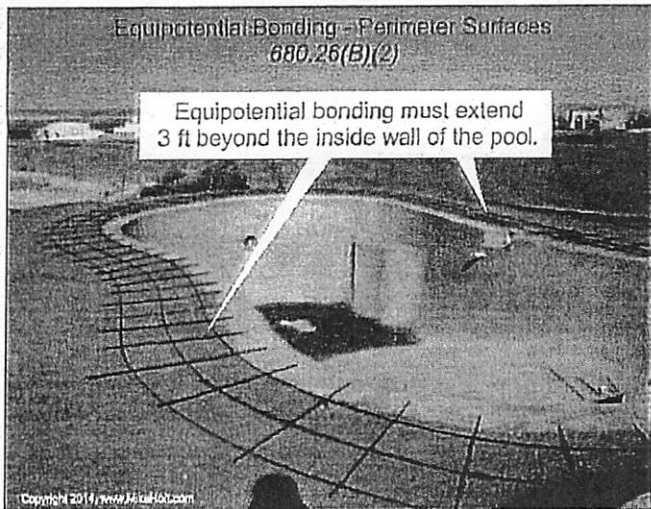

Figure 680-42

(b) **Alternative Means.** Where structural reinforcing steel isn't available (or is encapsulated in a nonconductive compound such as epoxy), equipotential bonding meeting all of the following requirements must be installed: Figure 680-43

- (1) The bonding conductor must be 8 AWG bare solid copper.
- (2) The bonding conductor must follow the contour of the perimeter surface.
- (3) Listed splicing devices must be used.
- (4) The required conductor must be located between 18 in. and 24 in. from the inside walls of the pool.

(5) The bonding conductor must be secured in or under the deck or unpaved surface within 4 in. to 6 in. below the subgrade.

(3) **Metallic Components.** Metallic parts of the pool structure must be bonded to the equipotential grid.

(4) **Underwater Metal Forming Shells.** Metal forming shells and mounting brackets for no-niche luminaires and speakers must be bonded to the equipotential grid.

(5) **Metal Fittings.** Metal fittings 4 in. and larger located within or attached to the pool structure, such as ladders and handrails must be bonded to the equipotential grid. Figure 680-44

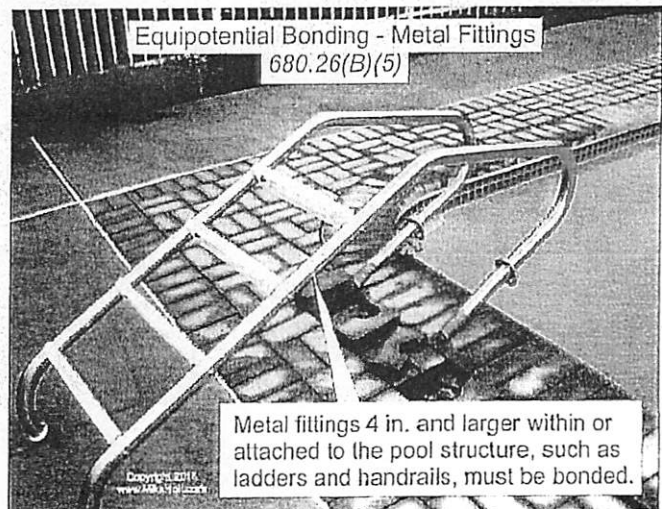

Figure 680-44

(6) **Electrical Equipment.** Metal parts of electrical equipment associated with the pool water circulating system, such as water heaters, pump motors, and metal parts of pool covers must be bonded to the equipotential grid. Figure 680-45

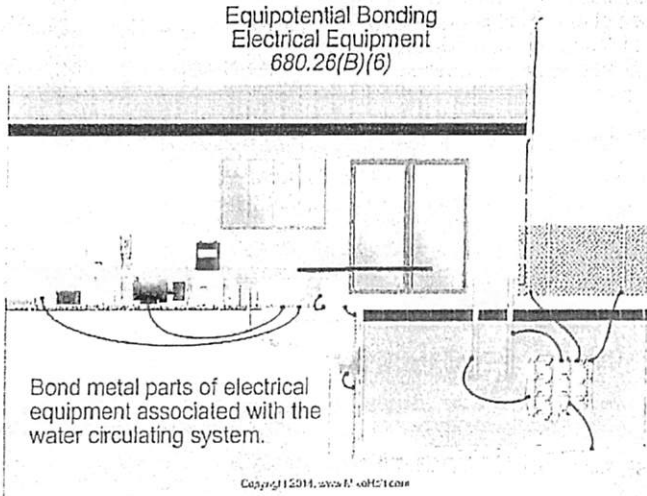

Figure 680-45

Ex: Metal parts of listed double-insulated equipment aren't required to be bonded.

(a) **Double-Insulated Water-Pump Motors.** If a double-insulated water-pump motor is installed, a solid 8 AWG copper bonding conductor must be provided for a replacement motor.

(7) **Fixed Metal Parts.** All fixed metal parts must be bonded to the equipotential grid, including but not limited to, metal-sheathed cables and raceways, metal piping, metal awnings, metal fences, and metal door and window frames. Figure 680-46

Ex 1: If separated from the pool structure by a permanent barrier that prevents contact by a person.

Ex 2: If located more than 5 ft horizontally from the inside walls of the pool structure. Figure 680-47

Ex 3: If located more than 12 ft measured vertically above the maximum water level.

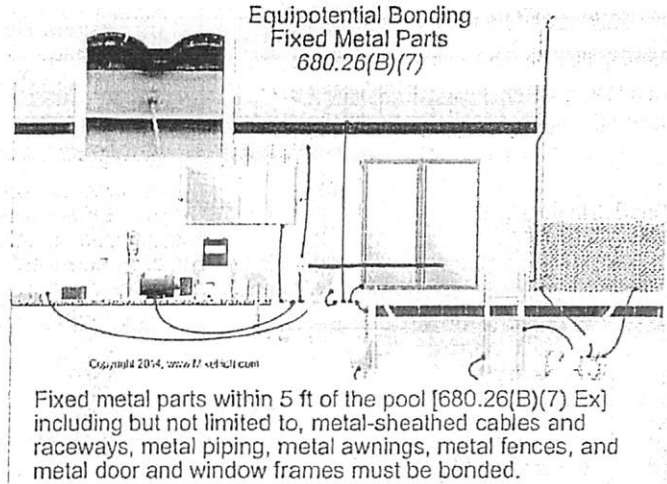

Figure 680-46

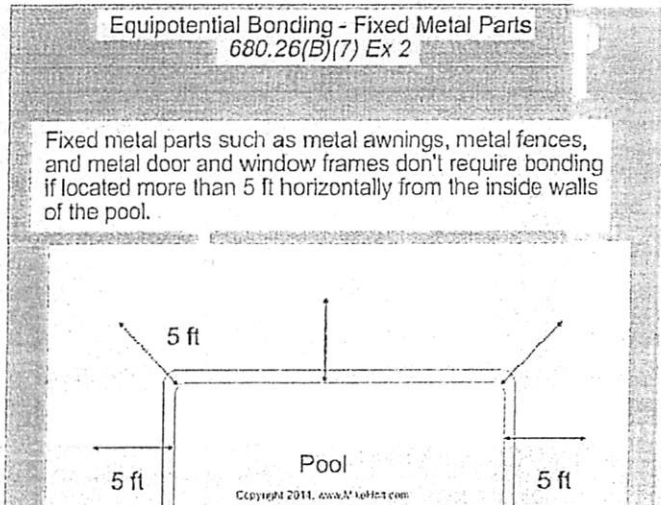

Figure 680-47

(C) **Pool Water.** If the pool water doesn't have an electrical connection to one of the bonded parts described in 680.26(B), an approved corrosion-resistant conductive surface that's at least 9 sq in. must be in contact with the water. The corrosion-resistance conductive surface must be bonded in accordance with 680.26(B), and be located in an area where it won't be dislodged or damaged or dislodged during normal pool usage. Figure 680-48

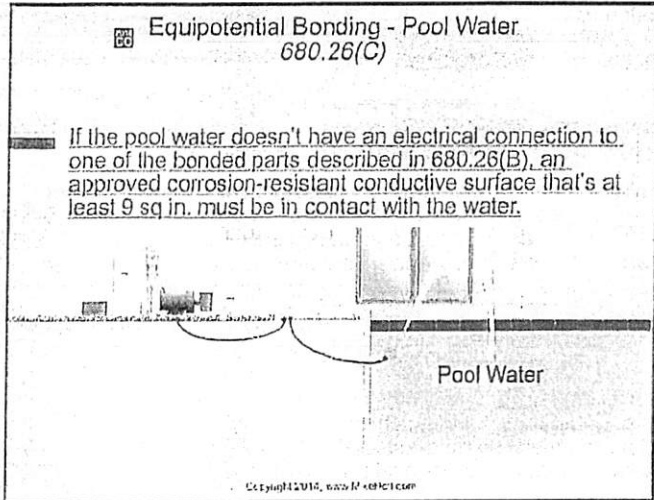

Figure 680-48

680.27 Specialized Equipment

(B) Electrically Operated Covers.

(1) **Motors and Controllers.** The electric motors, controllers, and wiring for an electrically operated cover must be located not less than 5 ft from the inside wall of a permanently installed pool, outdoor spa, or outdoor hot tub, unless separated by a permanent barrier.

(2) **GFCI Protection.** The branch circuit serving the electric motor and controller circuit must be GFCI protected.

Part III. Storable Pools, Storable Spas, and Storable Hot Tubs

680.30 General

Electrical installations for storable pools, storable spas, and storable hot tubs must also comply with Part I of Article 680.

Author's Comment:

- The requirements contained in Part I of Article 680 include the locations of switches, receptacles, and luminaires.

680.31 Pumps

Cord-connected pool pumps must be double insulated and have a means to ground the internal metal parts to an equipment grounding conductor installed with the power-supply conductors in the flexible cord. The cord must also have GFCI protection as an integral part of the attachment plug. Figure 680-49

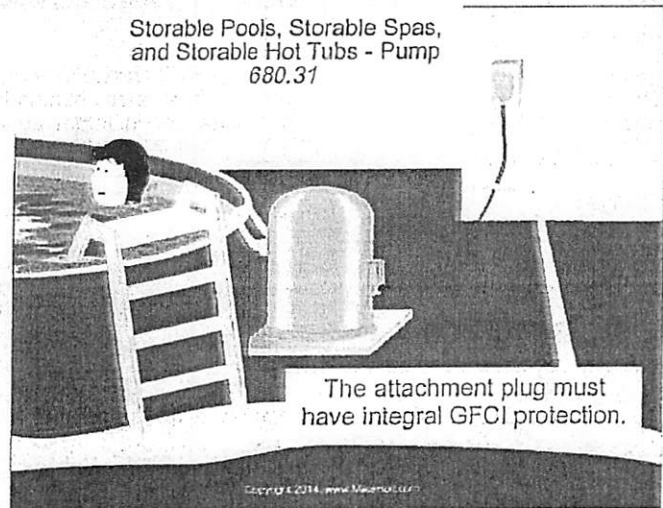

Figure 680-49

680.32 GFCI-Protected Receptacles

GFCI protection is required for electrical equipment associated with storable pools, and is also required for all 15A and 20A, 125V receptacles within 20 ft from the inside wall of a storable pool, storable spa, or storable hot tub. Figure 680-50

680.34 Receptacle Locations

Receptacles must not be located less than 6 ft from the inside walls of a storable pool, storable spa, or storable hot tub. The receptacle distance is measured as the shortest path an appliance cord would follow without passing through a wall, doorway, or window. Figure 680-51

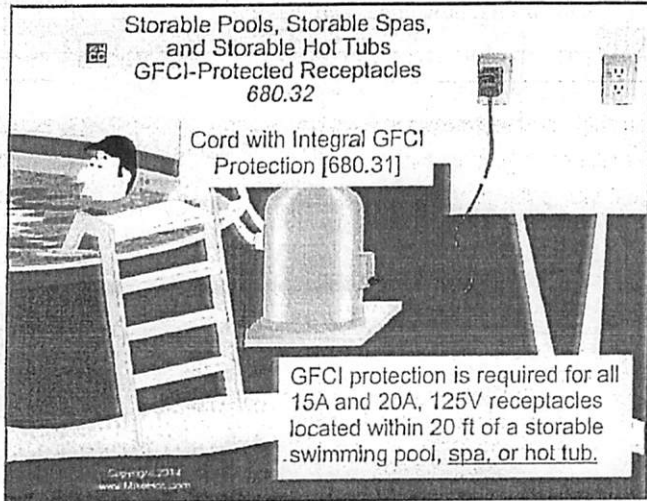

Figure 680-50



Figure 680-51

Part IV. Spas and Hot Tubs

680.40 General

Electrical installations for spas and hot tubs must comply with Part I as well.

680.41 Emergency Switch for Spas and Hot Tubs

In other than a single-family dwelling, a clearly labeled emergency spa or hot tub water recirculation and jet system shutoff must be supplied. The emergency shutoff must be readily accessible to the users and located not less than 5 ft away, adjacent to, and within sight of the spa or hot tub. Figure 680-52

Spa and Hot Tub - Emergency Shutoff 680.41

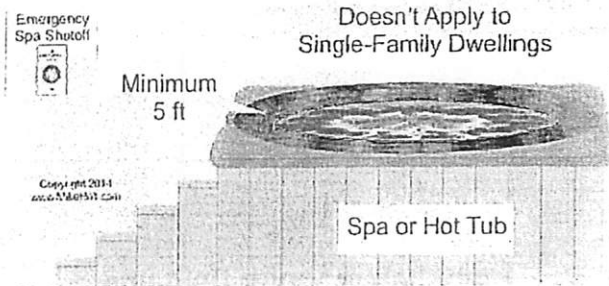

A clearly labeled, readily accessible, emergency shutoff must be installed at least 5 ft away, adjacent to, and within sight of the spa or hot tub.

Figure 680-52

Author's Comment:

- Either the maintenance disconnecting means required by 680.12 or a pushbutton that controls a relay located in accordance with this section can be used to meet the emergency shutoff requirement.
- The purpose of the emergency shutoff is to protect users. Deaths and injuries have occurred in less than 3 ft of water because individuals became stuck to the water intake opening. This requirement applies to spas and hot tubs installed indoors as well as outdoors.

680.42 Outdoor Installations

(B) Equipotential Bonding. Equipotential bonding of perimeter surfaces [680.26(B)(2)] isn't required for outdoor spas and hot tubs if they meet all of the following conditions: Figure 680-53

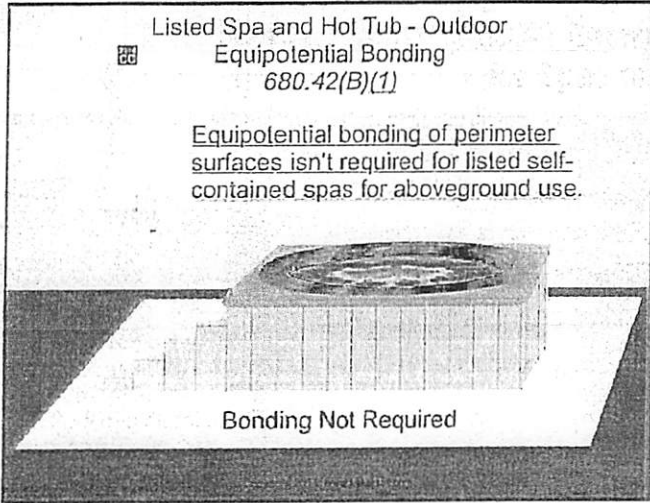

Figure 680-53

- (1) Listed as a self-contained spa for aboveground use.
- (2) Not identified as suitable only for indoor use.
- (3) Installed in accordance with the manufacturer's instructions and located on or above grade.
- (4) The top rim must be at least 28 in. above all perimeter surfaces that are within 30 in. measured horizontally from the spa or hot tub. Nonconductive external steps for entry to or exit from the spa can't be used to reduce or increase the rim height measurement.

(C) Interior Dwelling Unit Wiring for Outdoor Spas or Hot Tubs. Any recognized or permitted Chapter 3 wiring method containing an insulated copper equipment grounding conductor in a raceway or uninsulated within a cable and not smaller than 12 AWG in the interior of a dwelling unit for the connection to spa or hot tub equipment can be used for the connection to motor, heating, and control loads that are part of a self-contained spa or hot tub or a packaged spa or hot tub equipment assembly. Figure 680-54

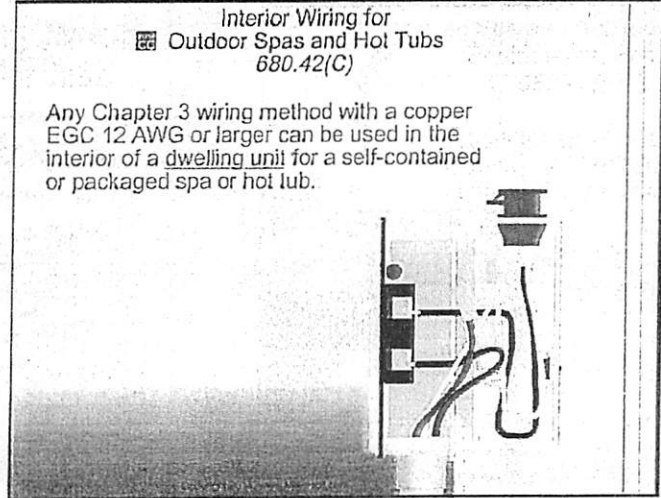

Figure 680-54

Ex 2: The equipotential bonding for perimeter surfaces contained in 680.26(B)(2) don't apply to a listed self-contained spa or hot tub installed above an indoor finished floor.

(A) Receptacles. At least one 15A or 20A, 125V receptacle must be located at least 6 ft, but not more than 10 ft, from the inside wall of the spa or hot tub. Figure 680-55

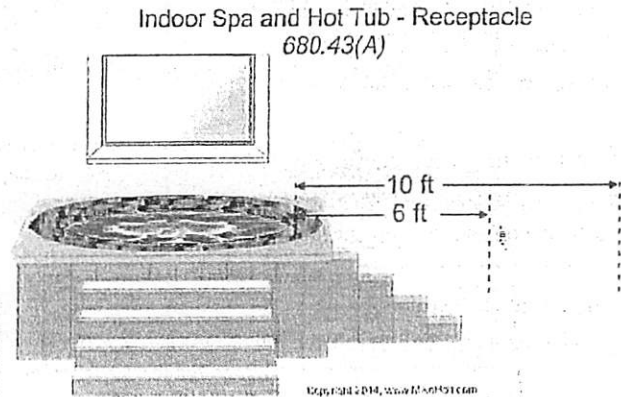

Figure 680-55

(1) Location. Other receptacles must be located not less than 6 ft, measured horizontally, from the inside walls of the indoor spa or hot tub.

680.43 Indoor Installations

Electrical installations for an indoor spa or hot tub must comply with Parts I and II of Article 680, except as modified by this section. Indoor installations of spas or hot tubs must be connected by any of the wiring methods contained in Chapter 3.

(2) **GFCI-Protected Receptacles.** Receptacles rated 30A or less at 125V, located within 10 ft of the inside walls of an indoor spa or hot tub, must be GFCI protected. Figure 680-56

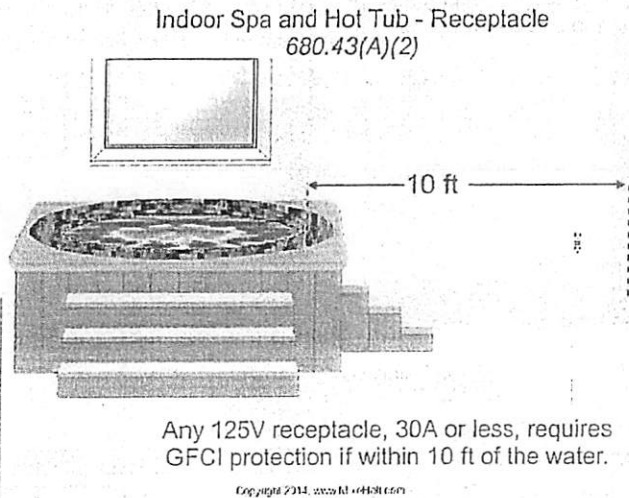

Figure 680-56

(3) **Spa or Hot Tub Receptacle.** Receptacles that provide power for an indoor spa or hot tub must be GFCI protected.

(4) **Measurements.** In determining the above dimensions, the distance to be measured must be the shortest path that the supply cord of an appliance connected to the receptacle would follow without piercing a floor, wall, ceiling, doorway with hinged or sliding door, window opening, or other effective permanent barrier.

(B) Luminaires and Ceiling Fans.

(1) **Elevation.** Luminaires and ceiling fans within 5 ft, measured horizontally, from the inside walls of the indoor spa or hot tub must be:

- (a) Not less than 12 ft above an indoor spa or hot tub if GFCI protection isn't provided.
- (b) Not less than 7½ ft above an indoor spa or hot tub if GFCI protection is provided.
- (c) Luminaires and ceiling fans can be mounted less than 7½ ft above an indoor spa or hot tub, if GFCI protection is provided and the installation meets either of the following requirements:

(1) Recessed luminaires with a glass or plastic lens, nonmetallic or electrically isolated metal trim, and suitable for use in damp locations.

Author's Comment:

- See the definition of "Location, Damp" in Article 100.

(2) Surface-mounted luminaires with a glass or plastic globe, a non-metallic body, or a metallic body isolated from contact, and suitable for use in damp locations.

(C) **Switches.** Switches must be located not less than 5 ft, measured horizontally, from the inside walls of the indoor spa or hot tub. Figure 680-57

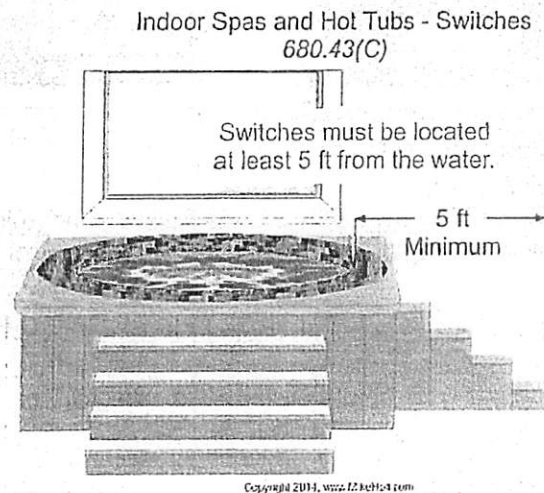

Figure 680-57

(D) **Bonding.** The following parts of an indoor spa or hot tub must be bonded together:

- (1) All metal fittings within or attached to the indoor spa or hot tub structure.
- (2) Metal parts of electrical equipment associated with the indoor spa or hot tub water circulating system unless part of a listed self-contained spa or hot tub.
- (3) Metal raceways and metal piping within 5 ft of the inside walls of the indoor spa or hot tub, and not separated from the indoor spa or hot tub by a permanent barrier.
- (4) All metal surfaces within 5 ft of the inside walls of an indoor spa or hot tub not separated from the indoor spa or hot tub area by a permanent barrier.

Ex 1: Nonelectrical equipment, such as towel bars or mirror frames, which aren't connected to metallic piping, aren't required to be bonded.

(E) Methods of Bonding. All metal parts associated with the spa or hot tub as described in 680.43(D) must be bonded by any of the following methods:

- (1) Interconnection of threaded metal piping and fittings
- (2) Metal-to-metal mounting to a common frame or base
- (3) A solid copper bonding jumper, insulated, covered, or bare, not smaller than 8 AWG

680.44 GFCI Protection

The outlet(s) that supplies a self-contained indoor spa or hot tub, a packaged spa or hot tub equipment assembly, or a field-assembled spa or hot tub must be GFCI protected. Figure 680-58

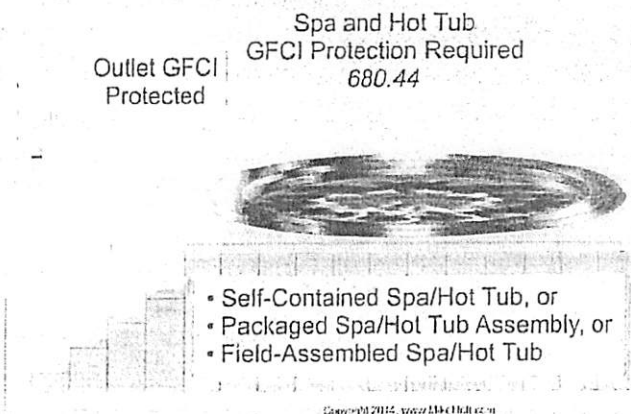

The outlet that supplies a self-contained spa or hot tub, a packaged spa or hot tub equipment assembly, or a field-assembled spa or hot tub must be GFCI protected.

Figure 680-58

Author's Comment:

- A self-contained spa or hot tub is a factory-fabricated unit that consists of a spa or hot tub vessel with water circulating, heating, and control equipment integral to the unit. A packaged spa or hot tub equipment assembly is a factory-fabricated unit that consists of water circulating, heating, and control equipment mounted on a common base intended to operate a spa or hot tub [680.2].

- Because this rule applies to all outlets and not just receptacle outlets, a hard-wired indoor spa or hot tub would require GFCI protection. See the definition of "Outlet" in Article 100.

(A) Listed Units. Additional GFCI protection isn't required for a listed self-contained spa or hot tub unit or listed packaged spa or hot tub assembly marked to indicate that integral GFCI protection has been provided for electrical parts within the unit or assembly. Figure 680-59

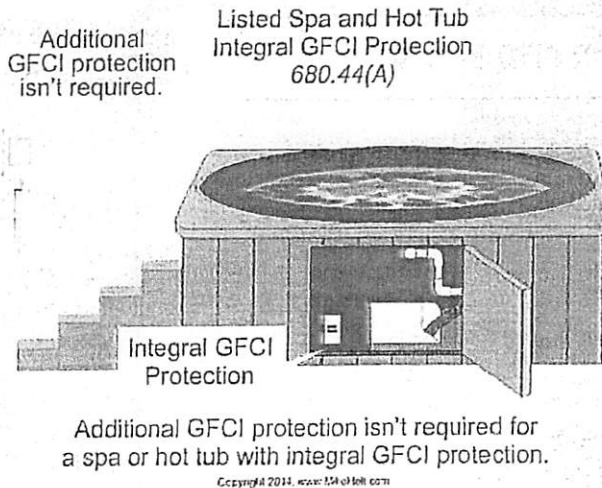

Figure 680-59

(B) Other Units. GFCI protection isn't required for a field-assembled spa or hot tub rated three-phase or that has a voltage rating over 250V, or has a heater load above 50A.

Part V. Fountains

680.50 General

The general installation requirements contained in Part I apply to fountains. In addition, fountains that have water common to a permanently installed pool must comply with Part I and Part II of this article. This part doesn't cover self-contained, portable fountains. Portable fountains must comply with Parts II and III of Article 422.

Author's Comment:

- A "Fountain" is defined as an ornamental, display, or reflection pool [680.2].